

## INTRADEPARTMENTAL CORRESPONDENCE

November 1, 2022  
1.1

**TO:** The Honorable Board of Police Commissioners

**FROM:** Chief of Police

**SUBJECT:** QUADRUPED UNMANNED GROUND VEHICLE PROGRAM  
DEPLOYMENT GUIDELINES AND PROCEDURES

### RECOMMENDED ACTIONS

That the Board of Police Commissioners review and approve the attached guidelines for the Quadruped Unmanned Ground Vehicle (QUGV).

### DISCUSSION

The Los Angeles Police Department is seeking to acquire a QUGV. Attached are the proposed guidelines and procedures for the deployment of the QUGV which is consistent with the newly established Department Manual Section 1/140.15, Acquisition and Annual Reporting of Certain Information Systems and Technologies.

The Special Weapons and Tactics (SWAT) teams average approximately 120 call-outs each year. It is estimated that current Unmanned Ground Vehicle (UGV) technology is utilized at approximately 10 to 15 percent of SWAT incidents. We assess that QUGV will be utilized at an even smaller rate due to the fact current UGV technology would be considered prior to any deployment of QUGV.

Should you have additional questions, please contact Deputy Chief David J. Kowalski, Commanding Officer, Counter-Terrorism and Special Operations Bureau, at (213) 486-8780.

Respectfully,



MICHEL R. MOORE  
Chief of Police

Attachments

# OFFICE OF THE CHIEF OF POLICE

## ADMINISTRATIVE ORDER NO.

### APPROVED BY THE BOARD OF POLICE COMMISSIONERS ON

#### **SUBJECT: QUADRUPED UNMANNED GROUND VEHICLE PROGRAM DEPLOYMENT GUIDELINES AND PROCEDURES**

**PURPOSE:** This Order establishes deployment guidelines and procedures specific to the Quadruped Unmanned Ground Vehicle (QUGV). As part of the Department's commitment to the Preservation of Life, the QUGV will greatly increase officer safety and minimize risks associated with life-threatening calls for service that meet the Special Weapons and Tactics (SWAT) deployment criteria.

#### **PROCEDURE:**

- I. Definition.** The QUGV refers to a ground vehicle operated on four legs without an onboard human presence.
- II. Responsibilities.** The QUGV will be assigned exclusively to Metropolitan Division's SWAT team and shall be reserved for use in high-risk incidents that meet SWAT deployment criteria. Special Weapons and Tactics personnel will be responsible for the safe operation of the QUGV during approved deployments and for documenting its use during deployment of the vehicle. Counter-Terrorism and Special Operations Bureau (CTSOB) will be responsible for the oversight and evaluation of the QUGV Program.
- III. Documentation and Inspection Procedures.** The request, approval, and/or disapproval of a QUGV deployment shall be documented on the SWAT After Action Report completed post deployment for review, transparency, and tracking. Metropolitan Division will be required to provide a quarterly report to CTSOB documenting QUGV field deployments. In addition, information regarding all QUGV deployments will be included in Innovation Management Division's annual Comprehensive Technology Report to the Honorable Board of Police Commissioners and comply with California Assembly Bill No. 481.
- IV. Approval for Deployment.** Any deployment of a QUGV shall be approved by the on-scene Incident Commander in concurrence with the Commanding Officer or Designee of CTSOB. If deployment is approved by CTSOB, a notification shall be made to the Director, Office of Special Operations, and the Chief of Police. If an incident is such that it requires the response of personnel assigned to Emergency Services Division (i.e., Hazardous Devices and Materials Section), the Commanding Officer, Emergency Services Division or appropriate representative shall also respond to the scene.
- V. Permissible Uses.** The QUGV may be deployed to provide enhanced situational awareness solely during the following circumstances or types of incidents:
  1. Active shooter incidents;
  2. Assessment of explosive devices and explosions;
  3. Hostage situations;
  4. Natural disasters;
  5. Hazardous materials incidents;

6. Search and rescue operations; and
7. Barricaded suspect incidents.

**Note:** A SWAT response for a barricaded suspect requires:

- The suspect is probably armed; and,
- Probable cause exists to believe that the suspect has been involved in a criminal act or is a threat to the lives and safety of the community and/or police; and,
- Is in a position of advantage, affording cover and/or concealment; or is contained in an open area and the presence of approach of police officers could precipitate an adverse reaction by the suspect; and,
- The suspect refuses to submit to a lawful arrest.

**VI. Prohibited Uses.** The QUGV shall not be deployed or used in violation of the City of Los Angeles Municipal laws, California State laws, or the United States Constitution. When required under the Fourth Amendment or other provisions of the law, Department personnel shall obtain a search warrant or valid consent, unless another lawful exception applies.

The QUGV shall not be equipped with any weapon systems including any non-lethal or less-lethal weapon technology, shall not be equipped with or use any facial recognition software or analysis capabilities, and the QUGV shall not be used for routine patrol duties or covert surveillance operations.

**Note:** The QUGV shall not be deployed in a manner exceeding the manufacturer's recommendations.

**VII. Protection of Privacy.** Department Manual Section 1/140.15, Acquisition and Annual Reporting of Certain Information Systems and Technologies, ensures that Department personnel follow practices consistent with the protection of privacy and civil liberties.

The QUGV technology uses secured radio frequencies and/or Wi-Fi to directly transmit images, audio and video from the onboard QUGV camera to the handheld monitor(s). It does not transmit to third parties and is encrypted to prevent interception by unauthorized entities such as news outlets or public groups. Department policy ensures personnel with access to such data follow practices that are consistent with the protection of privacy and civil liberties. Digital evidence (photographs, video, or audio) captured by the QUGV's cameras during deployment shall be safeguarded in accordance with current Department policy.

**VIII. Training.** Personnel approved to utilize or manipulate the QUGV shall be trained in operations of the unit in accordance with the Manufacturer Guidelines. In addition to QUGV functionality, unit operators, and those overseeing unit operations, shall be trained in the policy and legal limitations governing the use of the unit and in strict compliance with privacy laws.

**MONITORING RESPONSIBILITY:** The Commanding Officer, CTSOB, shall have monitoring responsibility for this directive.

**AUDIT RESPONSIBILITY:** The Commanding Officer, Audit Division, shall review this directive and determine whether an audit or inspection shall be conducted in accordance with Department Manual Section 0/080.30.

A handwritten signature in blue ink, appearing to be 'M. Moore', written over a light blue circular stamp.

**MICHEL R. MOORE**  
Chief of Police

Attachments

DISTRIBUTION "D"

# ACQUISITION OF INFORMATION SYSTEMS AND TECHNOLOGIES REVIEW AND EVALUATION REQUEST (AISTRER)

**1. Originating entity.**

Rank, Name & Serial No.: Lieutenant R. Lopez, Serial No. 25900

Area/division of Assignment: Metropolitan Division

Phone Number: (213) xxx - xxxx

**2. Category of the technology** (check those that apply to your requested technology).

Communication device

Transportation -  Small unmanned aircraft/aerial system (sUAS)

Robotic vehicle

Other: \_\_\_\_\_

Computer

Photo, video, audio recorder

Thermal imaging/sensing device

Biometric technology -  Facial recognition

DNA

Fingerprints

Retina recognition

Voice recognition

Other: \_\_\_\_\_

Geolocation tracking

Other: \_\_\_\_\_

**3. Manufacturer's description of the technology/product** (attach the product brochure if available).

**4. Is the technology/product requested for evaluation, replacing an existing technology/product?**  Yes  No

If yes, what is the current technology/product in use? \_\_\_\_\_

**5. Originating entity's proposed use.**

Describe the proposed use of the technology product: The QUGV will be deployed to provide enhanced situational awareness solely during the following circumstances or types of incidents: Active shooter incidents, assessment of explosive devices and explosions, hostage situations, disasters, hazardous materials incidents, search and rescue operations and barricaded suspects. The QUGV would prevent the need to insert SWAT or canine personnel into spaces where an armed individual could be hidden.

**6. Where will the technology/product be deployed?**

Geographic: Field

Venue: High-risk incidents

Investigation: Criminal

Tactical deployment: By SWAT personnel

Other: \_\_\_\_\_

# ACQUISITION OF INFORMATION SYSTEMS AND TECHNOLOGIES REVIEW AND EVALUATION REQUEST (AISTRER)

7. Has the requested technology/product been approved for use by the Department?

- ( ) Yes - Name the Department publication that approved it: \_\_\_\_\_  
(✓) No

8. Is there required training to use the technology/product?

- (✓) Yes. Name the required training: Unmanned Tactical Application 2-Day Course  
( ) No

9. Will data (photo, video, audio, biometric, geolocation, etc.) be collected, recorded, or captured?

- (✓) Yes ( ) No

If data will be collected, recorded, or captured utilizing the technology:

- Describe types of data: Images, audio and video
- Location data stored: Evidence.com - existing LAPD technology
- Data protection plan: Existing policy
- Would data be available for public access? ( ) Yes (✓) No  
Data retention/purge plan: Existing policy
- Will a third party (outside agency) share any of the collected data? ( ) Yes (✓) No
- If yes, name the agency(ies): \_\_\_\_\_

10. Who will be authorized to access/use collected data?

- Area/division authorized: Governed by existing Department policy
- Rank of personnel authorized access/use data: Governed by Dept policy

11. Fiscal impact of the technology/product acquisition.



- Quantity of technology/product requested: One
- Unit cost: \$277,917.80
- Expected life span of the technology: Five years +
- Expected annual maintenance cost: Warranty

12. Audit and oversight.

Is there a plan for audit and oversight of usage of the technology and collected data?

Explain: Metropolitan Division will provide a quarterly report to CTSOB to document QUGV deployments. Additionally, QUGV deployments will be included in Innovation Management Division's annual Comprehensive Technology Report to the BOPC.

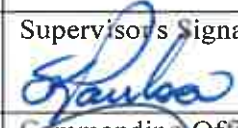
# ACQUISITION OF INFORMATION SYSTEMS AND TECHNOLOGIES REVIEW AND EVALUATION REQUEST (AISTRER)

Completed by (Name and Serial No.): Lieutenant R. Lopez, Serial No. 25900	Contact Number: (213) xxx-xxxx
Supervisor Reviewing (Name and Serial No.): Commander S. Paulson, Serial No. 30253	Supervisor's Signature: 
Commanding Officer Approving: Deputy Chief D. Kowalski, Serial No. 33157	Commanding Officer's Signature: 

FOR IMD USE ONLY	
Date request received:	August 18, 2022
Person reviewing:	Captain Anthony M. Espinoza, Serial No. 35423
Surveillance technology:	<input checked="" type="checkbox"/> Yes <input type="checkbox"/> No
Recommended for further acquisition review:	<input checked="" type="checkbox"/> Yes <input type="checkbox"/> No

# TECHNOLOGY USE AND DATA PRIVACY REPORT (TUDPR)

## Description of Technology

Product brochure attached (if available)

The QUGV refers to a ground vehicle operated on four legs without an onboard human presence. The manufacturer offers a variety of attachments and accessory, as identified in the attached brochure. However, the Department's proposed purchase will comprise of : One Spot Robot (Enterprise model) with arm, one Spot Camera with infrared and the purchase of a 2-Day Unmanned Tactical Application Course provided by the manufacturer.

## Proposed Purpose and Primary Use of the Technology

The QUGV may be deployed to provide enhanced situational awareness solely during the following circumstances or types of incidents: Active shooter incidents, assessment of explosive devices and explosions, hostage situations, disasters, hazardous materials incidents, search and rescue operations and barricaded suspects. The QUGV would prevent the need to insert SWAT or canine personnel into space where an armed individual could be hidden.

## Locations to be Deployed

- Location:  Public  Private
- Type of location: Various
- Geographical Area/division(s): Various

## Types and Sources of Data Collected

- Types of data collected/stored:

Images, video and audio recordings

- How is data collected:

The QUGV technology uses secured radio frequencies and/or Wi-Fi to directly transmit visual images, audio and video from the onboard QUGV cameras to the handheld monitor(s).



# TECHNOLOGY USE AND DATA PRIVACY REPORT (TUDPR)

- Will data be stored:  Yes  No

## Data Retention

- Proposed data retention/storage time period: Governed by existing Department policy.
- Mechanism(s) to delete data: Governed by existing Department policy.
- How is data retained and maintained?

All QUGV images, audio and video recordings will be stored via Evidence.com, an existing Department technology with approved policy.

- Projected cost of data storage: No additional cost to the Department

## Data Security

- Plan to safeguard data (i.e., encrypt data, cloud-based storage, restrict access):

All images, audio, and video recordings captured during a QUGV deployment, shall comply with Manual Section 3/405, Confidential Nature of Department Records, Reports, and Information.

- Plan to safeguard hardware:

All images, audio, and video recordings captured by the QUGV's cameras during deployment shall be safeguarded in accordance with current Department policy and Manual Section 3/405, Confidential Nature of Department Records, Reports, and Information. Department policy ensures personnel with access to such data follow practices that are consistent with the protection of privacy and civil liberties.

- Multi-Factor Authentication:  Yes  No

# TECHNOLOGY USE AND DATA PRIVACY REPORT (TUDPR)

## Potential Impact on Privacy and Civil Rights

The QUGV shall not be deployed or used in violation of the city of Los Angeles Municipal laws, California State laws, or the United States Constitution. When required under the Fourth Amendment or other provisions of the law, Department personnel shall obtain a search warrant or other lawful process, unless a lawful exception applies.

## Plan to Safeguard Privacy and Civil Rights

All images, audio, and video recordings captured during a QUGV deployment, shall comply with Manual Section 3/405, Confidential Nature of Department Records, Reports, and Information. Department policy ensures personnel with access to such data follow practices that are consistent with the protection of privacy and civil liberties.

## Third Party Sharing

- Will data be shared with a third-party?  Yes  No

If yes, with whom: \_\_\_\_\_

## TECHNOLOGY USE AND DATA PRIVACY REPORT (TUDPR)

- What procedures are in place to maintain security, including operational, administrative, technical, and physical safeguard against unauthorized access to the data?

All images, audio, and video recordings captured during a QUGV deployment, shall comply with Manual Section 3/405, Confidential Nature of Department Records, Reports, and Information.

### Public Access to the Data

- Can a member of the public access the data?  Yes  No
- What are the procedures for the public to gain access to the data?

All images, audio, and video recordings captured shall be subject to existing guidelines regarding legal discovery requests, Department authorized critical incident debriefs, or approved California Public Records Act requests.

## TECHNOLOGY USE AND DATA PRIVACY REPORT (TUDPR)

- Are there any functions of the investigative data gathering that may be subject to the Freedom of Information Act (FOIA)?  Yes  No
- Are there reasons to restrict public access to data?  Yes  No

### Fiscal Cost of the Technology and Funding Source

The estimated cost of the technology is approximately \$277,917.80, which will be funded by the Los Angeles Police Foundation. The purchase of a one-year extended warranty by the manufacturer at a cost of \$24,800.00 is included in the above-mentioned estimate. There are no monthly service or contract fees.

### Need and Cost for Additional Department Personnel to Operate the Technology

This technology will be exclusively utilized by Metropolitan Division's Special Weapons and Tactics personnel.

# TECHNOLOGY USE AND DATA PRIVACY REPORT (TUDPR)

## Third-Party Dependency and Cost to Operate and Maintain the Technology

- Is maintenance by a third-party required?  Yes  No If yes, explain.

The manufacturer will be the sole source for needed maintenance and repairs, as with all robotics. The additional extended warranty outlined in the estimate will further minimize costs.

- What are the processes to screen individuals to grant authorization to access and use data?

All images, audio, and video recordings captured by the QUGV's cameras during deployment shall be safeguarded in accordance with current Department policy and Manual Section 3/405, Confidential Nature of Department Records, Reports, and Information. Department policy ensures personnel with access to such data follow practices that are consistent with the protection of privacy and civil liberties.

- Will data be used for investigation or any other purpose?  Yes  No
- When and/or under what circumstance(s) can data be used?

Governed by existing Department policy.

# TECHNOLOGY USE AND DATA PRIVACY REPORT (TUDPR)

## Training Needed

- Is training needed for the technology?  Yes  No If yes or no, explain.

Personnel approved to utilize or manipulate the QUGV shall receive familiarization and implementation training in accordance with the 2-Day Unmanned Tactical Application Course provided by the manufacturer. This is a custom tailored training for the end-users on accompanying hardware and software. In addition to QUGV functionality, unit operators, and those overseeing unit operations, shall be trained in the policy and legal limitations governing the use of the unit and in strict compliance with privacy laws.

## Alternative to the Requested Technology

Alternatives to the requested QUGV include land-based robotics that rely on wheels or tracks. These types of robotics can easily become entangled in clutter or obstacles such as stairs, therefore are not viable options due to their limitation.

## Track Record of the Technology

This technology is currently in use for law enforcement, commercial, and industrial purposes. Its client list exceeds 100 names and is growing rapidly. Most recently, the Honolulu Police Department was added to its client list.



## Auditing and Oversight

- What mechanisms are in place for auditing and oversight?

Deployment of a QUGV shall be approved by the on-scene Incident Commander in concurrence with the Commanding Officer or Designee of CTSOB. The Commanding Officer, Audit Division, shall review this directive and determine whether an audit or inspection shall be conducted in accordance with Department Manual Section 0/080.30.

## TECHNOLOGY USE AND DATA PRIVACY REPORT (TUDPR)

- What is the frequency of inspections/audits? Quarterly and Annual reporting procedures
- What entity is responsible for auditing and oversight? C/O of CTSOB & Audit Div

Completed by (Name and Serial No.): Lieutenant R. Lopez, Serial No. 25900	Contact Number: (213) xxx-xxxx
Supervisor Reviewing (Name and Serial No.): Commander S. Paulson, Serial No. 30253	Supervisor's Signature: 
Commanding Officer Approving: Deputy Chief D. Kowalski, Serial No. 33157	Commanding Officer's Signature: 

(08/22)



FLYMOTION  
800-548-5844

4416 Eagle Falls Pl.  
Tampa, Florida  
33619-9611  
United States

Prepared For	Estimate Date	Estimate Number
Officer Billy Lee	10/18/2022	107761
Los Angeles Police Department		
Metropolitan Division		
2710 West Temple St.		
Los Angeles, California		
90026		
United States		

Description	Rate	Qty	Line Total
<b>SPOT Enterprise Package</b> • Base platform: Spot with the current software release • Spot battery (qty 2) • Spot battery charger (power loader) with cables • JXD tablet controller with the then current software release • Micro-USB charger for JXD tablet • Storage and transportation case for Spot and accessories	\$99,200.00	1	\$99,200.00
<b>SPOT Arm</b> • Equipped to operate through both semi-autonomous actions and telemanipulation, the arm will open doors, pick, place, push, or drag objects, and adapt to new situations at the push of a button or swipe of a screen.	\$64,000.00	1	\$64,000.00
<b>Spot CARE w/ Arm</b> <b>Spot CARE Service Plan</b> Included: • 100% coverage on your Spot robot for the first 12 months • Unlimited repairs* • Unlimited replacement* • Repair or replacement time: <10 business days • Includes Arm	\$24,800.00	1	\$24,800.00
*Subject to our Terms and Conditions of Sale			
<b>Boston Dynamics Spot Cam+ IR</b> Payload: Boston Dynamics Spot CAM+ IR	\$38,950.00	1	\$38,950.00
<b>FLYMOTION Ridgeback System w/Starter Kit</b> 1x FLYMOTION Ridgeback (S-Band)	\$37,979.00	1	\$37,979.00



- 1 x Ridgeback Kit for SPOT (Chasis, batteries, antennas, cables)
- 1 x Radio for Operator (Chasis, batteries, antennas, cables)
- 1 x Controller
- 1 x Android Tablet
- 1 x Juggernaut Case & Mount

FM Custom Spot Design	\$1,500.00	1	\$1,500.00
- Receive your agencies colors logos or crest on the robot.			

UTAC 2 Day Training (Client Location)	\$6,494.00	1	\$6,494.00
Unmanned Tactical Application Course: *UGV Familiarization and Implementation*			

Up to 6 students  
Each additional student is \$999

This is a custom tailored training for the end-user involving all aircraft, hardware, and software used by the end-user. Trainees will learn to use both aircraft, hardware, and any accompanying software to complete missions necessary to the end-users success.

Shipping	\$3,200.00	1	\$3,200.00
Ground Shipping (Insured)			

	Subtotal	276,123.00
	8.5% Discount	-23,470.46
	Tax	0.00

	Estimate Total (USD)	\$252,652.54
--	----------------------	--------------

<b>Grand Total</b> (With 10% Tax)	<b>\$277,917.80</b>
--------------------------------------	---------------------

**Terms**

- Payment due upon receipt (unless other terms have been agreed upon).
- Pricing valid for 45 days from the date issued.
- 3% Convenience charge on orders more than 2500.00 for credit card processing.
- Send orders to sales@flymotionus.com.
- Lead time will be confirmed upon receipt of a valid PO.
- Please inquire about our Training Classes.

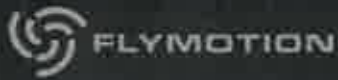

IN COLLABORATION WITH

BostonDynamics



# SPOT<sup>®</sup>

## THE NEXT GENERATION UGV



Spot<sup>®</sup>, developed by BostonDynamics and provided by FLYMOTION, brings *countless* possibilities for the future to enhance public safety, government, defense, and enterprise operations as an unmanned ground vehicle (UGV).

Spot's dynamic programmability also allows third-party payloads to be integrated into Spot with the use of the software development kit (SDK). Whether the mission at hand is rescue, inspection, threat assessment, navigation, mapping, or a need yet to be explored, FLYMOTION stands ready to support you with the hardware, custom integration, and training.

### VERSATILE APPLICATIONS

Creating custom methods of controlling Spot and programming autonomous missions expand the robot's capabilities. Spot's mounting rails, payload ports, and software development kit give end-users the ability to have Spot customized for their applications.

Spot goes where wheeled robots cannot while carrying a variety of payloads. With 360° vision and obstacle avoidance, the robot can be driven remotely or taught routes and actions to perform autonomous missions.

### ADVANCED TECHNOLOGY



## DEVELOPER PLATFORM

By integrating Spot with software and sensors, the robot can perform a variety of functions. From documenting construction progress to monitoring remote environments to adding situational awareness, Spot can accomplish the tasks at hand.

Spot's legs keep the robot stable while it quickly navigates stairs and difficult terrain. Register additional payload weight and watch as the system automatically adapts to keep the robot moving smoothly.

## REAL-WORLD MOBILITY

## PROGRESSIVE PERCEPTION

Spot's built-in stereo cameras provide depth information to produce 3D point clouds, mapping its surroundings, and avoiding obstacles. These cameras are primarily for the robot's own navigation but also provide the user with a live monochrome video feed that can be streamed through the control tablet or over the API. For high-definition, color images, or increased range in 3D mapping, explore Spot's payloads.

Spot autonomously navigates around obstacles in its path using real-time mapping conducted by the perception system. Spot also comes equipped with Autowalk, a simple tablet feature allowing users to record and replay autonomous missions.

## AUTONOMOUS NAVIGATION

## ADAPTABLE PAYLOADS

Spot can be tailored for a variety of applications. Select a payload or design your own using the software development kit. Two payload ports provide power and communication to the unit; the optional Spot GXP offers regulated power and Ethernet connectivity.

## SPOT<sup>®</sup> PAYLOADS

### SPOT CAM<sup>™</sup>

Captures spherical images with an optional PTZ camera featuring 30x optical zoom for detailed inspections.

### SPOT CORE<sup>™</sup> ●●●

Provides dedicated processing for applications requiring on-robot computation.

### SPOT ARM<sup>™</sup>

Enables mobile manipulation for tasks like opening doors and grasping objects. (ETA: Q1 2021)

### SPOT GXP<sup>™</sup>

Provides regulated power and an Ethernet port for easy payload integration.

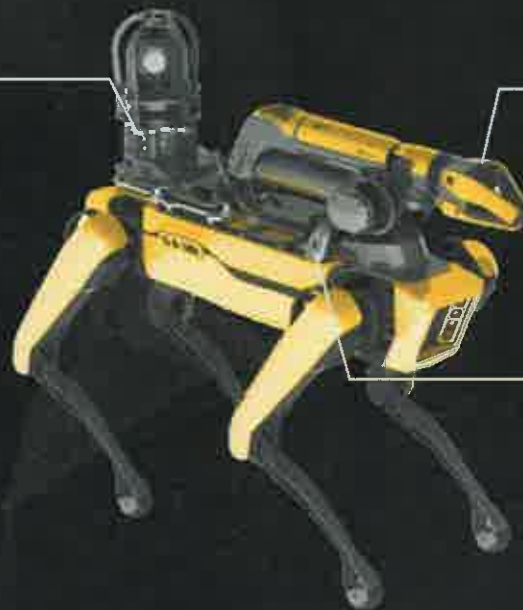

# SPOT® ADD-ONS

*FLYMOTION brings the capability and resources to upgrade an already-customized Spot. With or without add-on payloads, we can incorporate additional radios, sensors, and processors for the most precise unmanned ground vehicle solution desired.*



## CAM+IR (for Thermal Capabilities)

The Spot CAM+IR payload turns Spot into a powerful inspection tool with purpose-built cameras and turnkey integration. Spot CAM+IR features a color ring camera with a 360° field of view, for complete situational awareness while remotely operating the robot. A pan-tilt-zoom (PTZ) color camera with a FLIR® thermal camera adds a powerful 30x optical zoom, enabling detailed inspections from a distance. Integrated high-sensitivity microphones and amplified speakers enable remote auditory inspections and two-way communications with operators in the field.

Spot CAM+IR is fully integrated with Spot's tablet controller as well as Spot's Scout software. Stream video from the camera to confidently tele-operate around your site. Get eyes on remote or hazardous environments with the PTZ camera, focusing on the inspection details that matter. Capture high quality photos manually or automatically with Autowalk, Spot's out-of-box autonomy system. Spot CAM+IR is purpose-built to collect data in challenging environments you'd rather avoid. Its image sensors are optimized for low light and its included LED illuminators enable 24/7 operations. The payload is IP65 sealed and can operate from -4°F to 113°F.

Developers can further customize Spot CAM+ to their applications using its GRPC API, fully available via the Spot SDK. Audio and video streams are served by WebRTC for easy integration into your application.

### DIMENSIONS

Length = 334 mm (13.1 in)  
Width = 227 mm (8.9 in)  
Height = 357 mm (14.1 in)  
Weight = 7.5 kg (16.4 lbs)

### PTZ CAMERA

Resolution = 2MP, 1080p  
Optical zoom = 30x zoom  
Pointing accuracy = 2°  
Range of motion = 170°/sec  
Tilt range = -30 to 270°

### ENVIRONMENT

Ingress protection = IP65  
Operating temp = -4°F to 113°F

### 360 CAMERA

Field of view = 360 x 170°  
Camera resolution = 10MP  
Image size = 9600x4800  
Camera sensor = 5x Sony IMX290  
Lens focal length = 2.16 mm  
Lens aperture = F2.0

### IR CAMERA

Scene temp range = -40°C to +550°C  
Video speed = 7.5 Hz  
FoV = 69 x 56°  
Image resolution = 640 x 512  
Accuracy = radiometric ±5°C

### AUDIO

Input = Sennheiser MKE-600  
Storage = Removable 256GB USB 3.1

### WHAT'S INCLUDED

Radiometric thermal camera  
30x optical PTZ camera  
Integrated 360 RGB camera  
Sennheiser MKE-600 shotgun microphone  
Two-way communication  
LED illumination x3  
USB sticks mounting kit  
Shielded ribbon cable (225 mm)



# SPOT® ADD-ONS

*FLYMOTION brings the capability and resources to upgrade an already-customized Spot. With or without add-on payloads, we can incorporate additional radios, sensors, and processors for the most precise unmanned ground vehicle solution desired.*



## CAM (for Awareness)

The Spot CAM payload integrates several additional capabilities making Spot mission-ready right out of the box. Spot CAM features a color ring camera with a 360° field of view for complete situational awareness with remote operation. Integrated high-sensitivity microphones and amplified speakers enable remote auditory inspections and two-way communications with operators in the field. Spot CAM is fully integrated with Spot's tablet. Stream video from the camera to confidently

teleoperate around your site and get eyes on remote or hazardous environments. Capture high-res photos manually or automatically with Autowalk, Spot's out-of-box autonomy system. Awareness includes 3 USB drives and a mounting kit.

Spot CAM is purpose-built to collect data in challenging environments that are best left unmanned. Its image sensors are optimized for low light and included LED illuminators enable 24/7 operations.

- Length = 334 mm (13.1 in)
- Width = 203 mm (8.0 in)
- Height = 130 mm (5.1 in)
- Weight = 3.1 kg (6.7 lbs)
- Ingress protection = IP65
- Operating temperature = -4°F to 113°F
- Panoramic field of view = 360 x 170°
- Panoramic camera resolution = 10MP
- Panoramic image size = 9600x4800
- Panoramic camera sensor = 5x Sony IMX290
- Panoramic lens focal length = 2.16 mm
- Panoramic lens aperture = F2.0



## GXP (General Expansion Payload)

The Spot GXP jump-starts payload integration by providing several breakout ports from Spot's main payload port. While the standard payload ports on Spot are designed for maximum flexibility, the GXP is designed to get you up and running quickly with more standard power and communication options. This expansion payload regulates Spot's battery power and provides

several voltage options appropriate for connecting laptops, processors, radios, and sensors. It also breaks out the main payload port into a conventional RJ-45 jack for 1000 Base-T Ethernet, along with other signals, like the robot's PPS (pulse per second) source.

- Length = 324 mm (12.8 in)
- Width = 168 mm (6.6 in)
- Height = 93 mm (3.7 in)
- Weight = 4.2 kg (9.3 lbs)
- Capacity = 605 Wh
- UL/ULC and CB Certified per IEC 62133; UN 38.3 Certified

## CAM+ (for Inspection)



The CAM+ payload turns Spot into a powerful inspection tool with purpose-built cameras and turn-key integration. Spot CAM+ features a color ring camera with a 360° field of view for complete situational awareness via remote operation. A pan-tilt-zoom (PTZ) color camera adds a powerful 30x optical zoom, enabling detailed inspections from a distance. Integrated high-sensitivity microphones and amplified speakers enable remote auditory inspections and two-way communications with operators in the field.

Spot CAM+ is fully integrated with Spot's tablet. Stream video from the camera to confidently teleoperate around your site. Get eyes on remote or hazardous environments with the PTZ camera, focusing on the critical inspection details. Capture high-res photos manually or automatically with Autowalk, Spot's out-of-box autonomy system. CAM+ includes 3 USB drives and a mounting kit.

Spot CAM+ is purpose-built to collect data in challenging environments that are best left unmanned. Its image sensors are optimized for low light and included LED illuminators enable 24/7 operations. *Spot CAM+ can be customized to your application using GRPC API, fully available via the Spot SDK. Audio and video streams are served by WebRTC for easy integration.*

- Length = 334 mm (13.1 in)
- Width = 203 mm (8.0 in)
- Height = 330 mm (13.0 in)
- Weight = 6.5 kg (14.3 lbs)
- PTZ range of motion = 170°/sec
- PTZ tilt range = -30 to 130°
- PTZ resolution = 2MP, 1080p video, 30x zoom
- Operating temperature = -4°F to 113°F
- Panoramic field of view = 360 x 170°
- Panoramic camera resolution = 10MP
- Panoramic image size = 9600x4800
- Panoramic camera sensor = 5x Sony IMX290
- Panoramic lens focal length = 2.16 mm
- Panoramic lens aperture = F2.0
- Ingress protection = IP65

## SPOT CORE (Edge CPU)



The Spot CORE is an additional processor for development. While any device connected to Spot's network can run custom code through Spot's SDK, running locally on Spot CORE enables high-bandwidth low-latency connections. This payload connects directly to the payload port for power and networking and comes with an Ubuntu 18.04 operating system with the SDK pre-loaded. Unlike the computers inside Spot, this system is open to

development. For special system requirements, you can format the disk and install your own OS. The CORE is outfitted with every port you need for rapid development:

- 3x USB 3.0
- 2x USB 2.0
- HDMI
- Ethernet
- RS232 Serial
- 2x DisplayPort
- Length = 250 mm (9.8 in)
- Width = 190 mm (7.5 in)
- Height = 84 mm (3.3 in)
- Weight = 2000 g (4.4 lbs)
- Motherboard = i5 Intel® 8th Gen (Whiskey lake-U) Core™ CCG Lifecycle
- RAM = 16GB DDR4 2666 MHz
- Storage = 512 GB SSD
- OS = Ubuntu Desktop 18.04 LTS 64-bit
- Ingress protection = IP54
- Operating temperature = 32°F to 122°F

## Enhanced Autonomy Package (EAP for LIDAR)



The Spot EAP improves Spot's autonomy by enabling the robot to create larger and more accurate maps. Spot's base 3D cameras have an effective range of four meters for autonomous mapping. The LIDAR in this payload increases Spot's sensing range and allows the robot to navigate spaces with features up to 328 feet (100m) away.

Spot's base cameras work well for autonomy in (1) small, indoor spaces like office buildings and (2) industrial settings where walls are less than 13.12 feet (4m) away from the robot. LIDAR helps Spot autonomously navigate in (1) large indoor spaces like warehouses, (2) outdoor spaces near buildings with features less than 328 feet (100m).

This package includes a CPU (Spot CORE) and Velodyne LIDAR which come pre-configured to enhance Spot's autonomy. Developers can also run their own software on the CORE's CPU.

- Length = 300 mm (11.8 in)
- Width = 190 mm (7.5 in)
- Height = 162 mm (6.4 in)
- Weight = 3.6 kg (8.0 lbs)
- Model = Velodyne VLP-16
- Measurement range = 100 m
- Field of view (horizontal) = 360°
- Rotation rate = 5 Hz - 20 Hz
- Operating temperature = -10 to 60°C
- Storage temperature = -40 to 105°C
- Power = 8 W
- Voltage = 9-18 V
- Range accuracy = Up to ±3 cm
- Field of view (vertical) = +15.0° to -15.0° (30°)
- Sensor = 16 Channels
- Angular resolution (vertical) = 2.0°
- Angular resolution (horizontal) = 0.1°—0.4°
- Ingress protection = IP67
- Laser product = Class 1 eye-safe per IEC 60825-1:2007 & 2014; 903nm wavelength
- Integrated web server (monitoring & configuration)



## CORE AI (EDGE GPU)

The Spot CORE AI is a complete development environment for running computationally-intensive tasks like machine learning. This payload connects directly to the payload port for power and networking and comes with an Ubuntu 18.04 OS with our SDK pre-loaded. Unlike the computers inside Spot, this system is open to developers; for special system requirements, you can format the disk and install your own operating system (OS).

The Spot CORE AI is built to handle the same operating temperatures and even higher ingress protection standards than Spot. Deploy your software into the same challenging environments as Spot, from winter snow to summer rain. Spot CORE AI is built with some of the highest performing components ever integrated in an environmentally hardened system: an Intel Xeon E3-1515M and Nvidia Quadro P5000 GPU. The CORE AI is outfitted with every port you need for rapid development:

- HDMI
- 2x 1000 Base-T Ethernet RJ-45
- 2x USB-3 Type A
- 2x USB-3 Type C
- Power: 12V 4A, 24V 2.3A, 5V 8A
- RS232 Serial
- MiniPCIe (internal, occupied w/ LTE modem in some configurations)
- Length = 240 mm (9.4 in)
- Width = 185 mm (7.3 in)
- Height = 74 mm (2.9 in)
- Weight = 3.45 kg (7.6 lbs)
- Ingress protection = IP67
- Operating temperature = -20 to 45°C
- SSD = 480GB mSATA SSD
- CPU = Intel Xeon E3-1515M V5
- CPU RAM = 32 GB
- GPU = NVIDIA P5000
- Peak power draw = 210W

## SPOT TABLET



- Height = 143.6 mm (5.7 in)
- Width = 274 mm (10.8 in)
- Depth = 53 mm (2.1 in)
- Weight = 580 g (1.3 lbs)
- 7" diagonal Touch Screen
- Resolution = 1920x1200
- Tablet controller configured
- Tablet case and charger with Spot app, Android 8.1

## SPOT BATTERY



- Length = 324 mm (12.8 in)
- Width = 168 mm (6.6 in)
- Height = 93 mm (3.7 in)
- Weight = 4.2 kg (9.3 lbs)
- Capacity = 605 Wh
- UL/ULC per IEC 62133
- CB Certified per IEC 62133
- UN 38.3 Certified

## SPOT CHARGER



- Length = 191 mm (7.5 in)
- Width = 305 mm (12.0 in)
- Height = 152 mm (6.0 in)
- Weight = 4.8 kg (10.5 lbs)
- UL/ULC Certified
- CE Cert, CB certified,
- FCC Part 15A/ICES -003 (A)

## SPOT CARE



Spot CARE minimizes your downtime and maximizes your productivity with Spot, allowing you to utilize the platform to the fullest with peace of mind. Receive expedited repair services and VIP support for one year. In addition, Spot CARE includes free hardware reliability upgrades delivered at the time of repair or during scheduled maintenance and can be renewed twice per unit.

- 100% coverage on your Spot robot for 12 months, after standard warranty expires
- Unlimited repairs\* and unlimited replacement\* (\*subject to terms and condition of sale)
- Repair or replacement time: <10 business days



# SPOT<sup>®</sup> SPECIFICATIONS

## Base Spot Dimensions

<i>Length</i>	1100 mm (43.3 in)
<i>Width</i>	500 mm (19.7 in)
<i>Height (standing)</i>	840 mm (33.1 in)
<i>Height (sitting)</i>	191 mm (7.5 in)
<i>Net Weight</i>	32.5 kg (71.7 lbs)

## Battery

<i>Capacity</i>	605 Wh
<i>Average Runtime</i>	90 minutes
<i>Standby Time</i>	180 minutes
<i>Recharge Time</i>	120 minutes
<i>Weight</i>	4.2 kg (9.26 lbs)

## Connectivity

<i>WiFi-enabled</i>	Yes
<i>Ethernet-enabled</i>	Yes

## Case

<i>Length</i>	1330 mm (52.4 in)
<i>Width</i>	680 mm (26.8 in)
<i>Height</i>	560 mm (22.0 in)

## Payload

<i>Max Weight</i>	14 kg (30.9 lbs)
<i>Mounting Area (LxWxH)</i>	0.85 m x 0.24 m x 0.27 m
<i>Mounting Interface</i>	M5 T-slot rails
<i>Connector</i>	DB25 (2 ports)
<i>Power Supply Integration</i>	Unregulated DC, 150W Available software API and hardware interface control document

## Safety

<i>E-Stop</i>	Enabled via controller
<i>Collision Avoidance</i>	Maintains set distance from people and obstacles

## Environment

<i>Ingress Protection</i>	IP54
<i>Operating Temp.</i>	-20°C to 45°C

## Sensing

<i>Field of view</i>	360°
<i>Range</i>	4 m (13 ft)
<i>Lighting</i>	>2 Lux

## Locomotion

<i>Max Speed</i>	1.6 m/s
<i>Max Slope</i>	+/- 30°
<i>Max Step Height</i>	300 mm (11.8 in)

## Controller

<i>Length</i>	274.1 mm (10.8 in)
<i>Width</i>	143.6 mm (5.65 in)
<i>Height</i>	53.0 mm (2.09 in)
<i>Weight</i>	580 g (1.28 lbs)
<i>Touch Screen Size</i>	7" diagonal
<i>Resolution</i>	1920x1200



If you're interested in Spot, Spot payloads, or custom integration,  
please email our staff at [sales@flymotionus.com](mailto:sales@flymotionus.com).

# SPOT ENTERPRISE

Meet the robot designed to fully automate sensing and inspection in remote or hazardous environments.



## True Autonomy

Self-charging allows Spot to autonomously perform routine or on-demand data collection in remote locations with no human interaction. Built-in dock detection and an easy-to-use tablet interface allows Spot to return home to charge at the push of a button or call of a program, without any other operator directions.

## Upgraded Functionality

In addition to all the basic capabilities of Spot Explorer, the Spot Enterprise package leverages upgraded hardware to further improve safety, communications, and behavior on remote sites. With longer Autowalk missions, enhanced WiFi, and an Ethernet connection while docked, Spot Enterprise provides ultimate autonomous data capture and post-mission data download.



# INTRODUCING THE SPOT DOCK

## Remote Self-Charging Station

Meet the self-charging station that transforms Spot into a truly autonomous remote inspection tool.

The Spot Dock will help increase predictability and improve safety on your sites with enhanced remote and autonomous operations.

As part of the Spot Enterprise package, the self-charging dock will support longer data-collection missions and routine inspection tasks.



### Automated Self-Charging

Dock autonomously using the tablet or through the API. With built-in dock detection, Spot will return home to charge at the push of a button or call of a program, without any other operator directions.

### Longer Missions

Utilize multiple docks on site to facilitate long missions on remote sites. Docks come with unique fiducials, allowing Spot to identify them in an environment requiring multiple charging stations.

# SPOT® DOCK SPECIFICATIONS

## Dimensions

Length	1140 mm (44.9 in)
Width	474 mm (18.7 in)
Height	483 mm (19 in)
Mass/Weight	~ 22 kg (50 lbs)

## Power

Input	90 — 277 VAC
Output	58V at 12A
Charge Time	2 — 3.5 hours* (varies based on table below)

## Environment

Operating Temp	-20°C — 35°C (-4°F — 95°F)
Lighting	Ambient light required
Mounting	Bolt/tie down locations provided

## Connectivity

Gigabit Ethernet passthrough to robot

## Certifications

UL1564, NEMA 2; IEC 61558 to follow

Ambient Temperature	80% Charge	100% Charge
25°C (77°F)	50 minutes	2 hours
35°C (95°F)	2.5 hours	3.5 hours

Space Needed for Charging

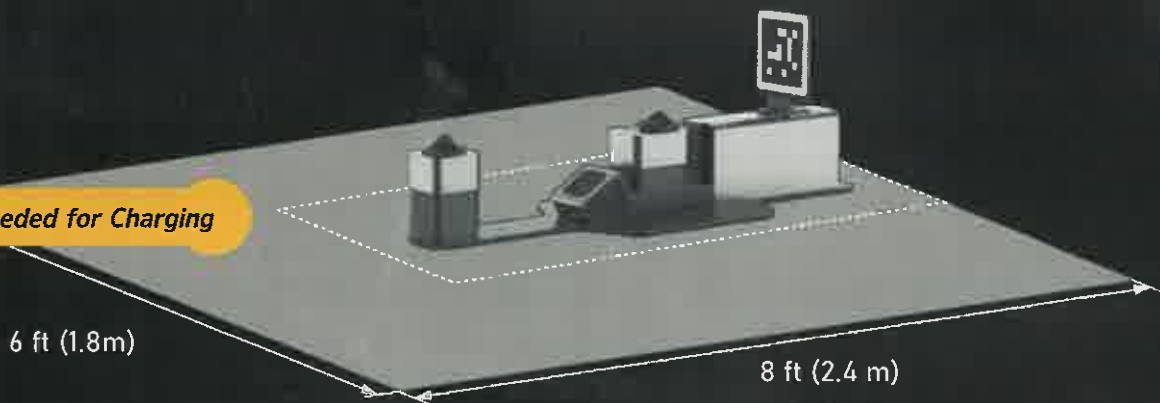

## Which SPOT Model is Right for You?

FEATURES	SPOT EXPLORER	SPOT ENTERPRISE
Tablet Control	Included	Included
Autowalk	Missions limited to 1000m in length	Unlimited mission lengths
WiFi	2.4GHz b/g/n	Dual band 802.11ac support (availability depends on region)
Payload power	Always on	Toggle via software in tablet or API
Self-charging	-----	Includes dock
High-speed data offload	-----	Quickly offload mission data through dock Ethernet connectivity
Metrics opt-out	-----	Opt-out of sending robot performance metrics back to Boston Dynamics
Enhanced safety options	-----	Safely stop function PL <sub>1</sub> category 3 per ISO 13849-1 available on payload ports



# SPOT® ARM

## Tablet Behaviors

**GRASPING, PICKING, PLACING** — Manually or semi-autonomously grasp, lift, carry, place, and drag a wide variety of objects, including handles, door knobs, tools, etc.

**CONSTRAINED MANIPULATION** — Semi-autonomously manipulate objects with constrained movement (e.g. turn valves, pull levers, open drawers).

**DOOR OPENING** — Semi-autonomously turn handles and open standard push and pull doors.

*Meet the mobile robot arm designed to enable you to act on data insights and perform real, physical work in human-centric environments.*

*Equipped to operate through both semi-autonomous actions and tele-manipulation, the arm will open doors, pick, place, push, or drag objects, and adapt to new situations at the push of a button or swipe of a screen.*

## API Options

### END-EFFECTOR CONTROL

- Specify position, velocity, and force trajectories in Cartesian space
- Point the end-effector at a point in the world
- Perform tasks in contact with environment (i.e. drawing, wiping, etc.)

### JOINT-SPACE CONTROL

- Specify joint angles and velocities
- Move to predefined configurations



# SPOT® ARM SPECIFICATIONS

## General

Degrees of Freedom	6° + gripper
Length (at full extension)	984 mm (38.7 in)
Mass/Weight (including gripper)	8 kg (17.6 lbs)
Maximum Endpoint Speed	10 m/s
Maximum Lift Capacity*	Up to 11 kg (24.3 lbs)
Continuous Lift Capacity* (0.5 m extension)	5 kg (11 lbs)
Max. Drag Capacity* (on carpet)	Up to 25 kg (55.1 lbs)

## On Robot

Total Mass/Weight	39.7 kg (87.5 lbs)
Max. Reach Height	1800 mm (70.9 in)

## Gripper

Depth	90 mm (3.5 in)
Max. Aperture	175 mm (6.9 in)
Peak Clamp Force	130 N
Integrated Sensors	ToF, IMU, 4K RGB**
Accessory Port	Gigabit Ethernet, 50W power, camera sync (PPS)

## Environment

Operating Temperature	-20°C to 45°C (-4°F to 113°F)
Ingress Protection	Water and dust resistant

\* Payload capacities measured at 22°C

## Joint Range of Motion + Link Lengths (mm)

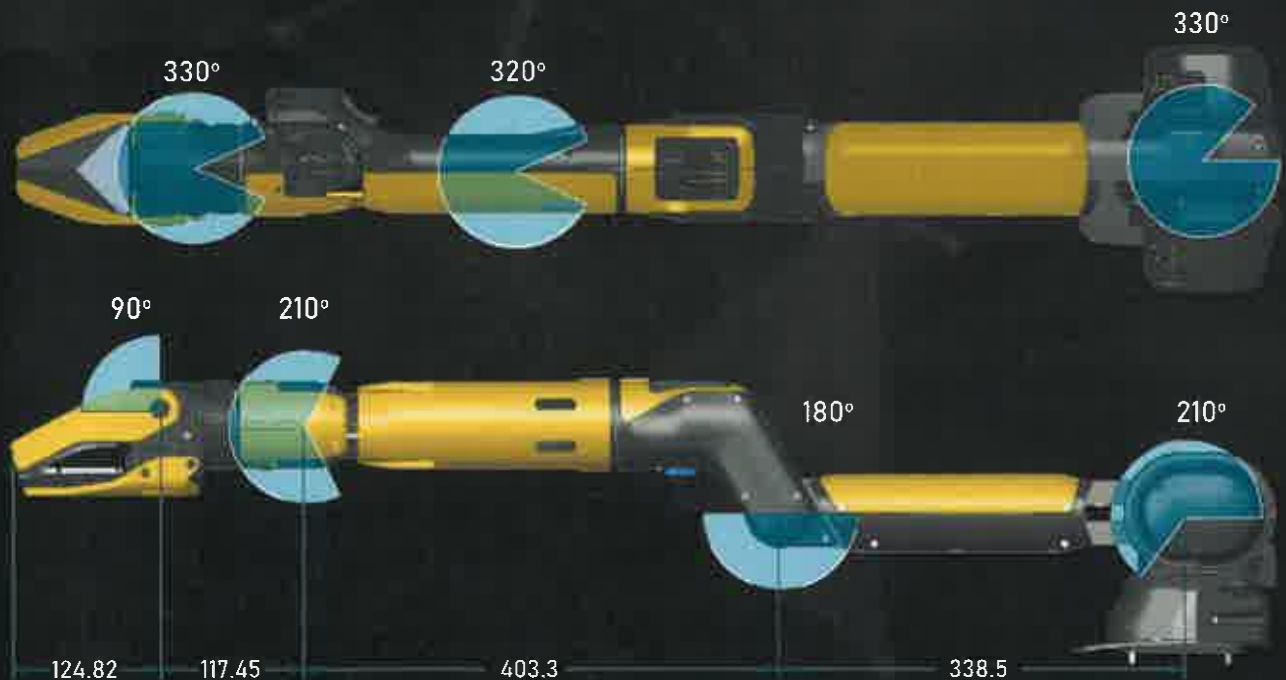

If you're interested in Spot, Spot payloads, or custom integration,  
please email our staff at [sales@flymotionus.com](mailto:sales@flymotionus.com).

# SCOUT



Scout is a web-based application that enables operators to control their fleet of Spots from a virtual control room. Operators can use Scout to take Spot anywhere a person could go on-site, allowing them to inspect critical equipment or hazardous areas from afar. The software is designed with a simple user interface to run pre-programmed autonomous missions or manually control the robot. Using Scout, operators can walk or pose the robot as well as capture images and thermal data of gauges, pipes, and more using the Spot CAM+IR thermal imaging payload.

When used with Spot Enterprise, users can tell Spot to self-charge on its dock at the push of a button or program it as part of a mission. Scout supports multiple Spots and multiple users on a single server. One driver and multiple viewers can see through Spot at a time. If an operator comes across a leak or other problem in their facility, they can send a link to a supervisor who can quickly assess the situation by opening the view-mode in their browser.

Scout can run over a VPN, or you can choose to run Scout in an isolated network with as tight restrictions as you require. The Scout system never needs to connect to the Internet. All access to Scout is restricted to authenticated users only, and all data is encrypted in transit and at rest.

Scout runs on the Site Hub, a 1U rack-mounted network appliance which is included with your subscription. The Site Hub is installed on-site and communicates to your Spots using your existing WiFi infrastructure.

*If you're interested in Spot, Spot payloads, custom integration and software management, please email our staff at [sales@flymotionus.com](mailto:sales@flymotionus.com).*

# Spot<sup>®</sup> Information for Use

v1.1 Original Instructions

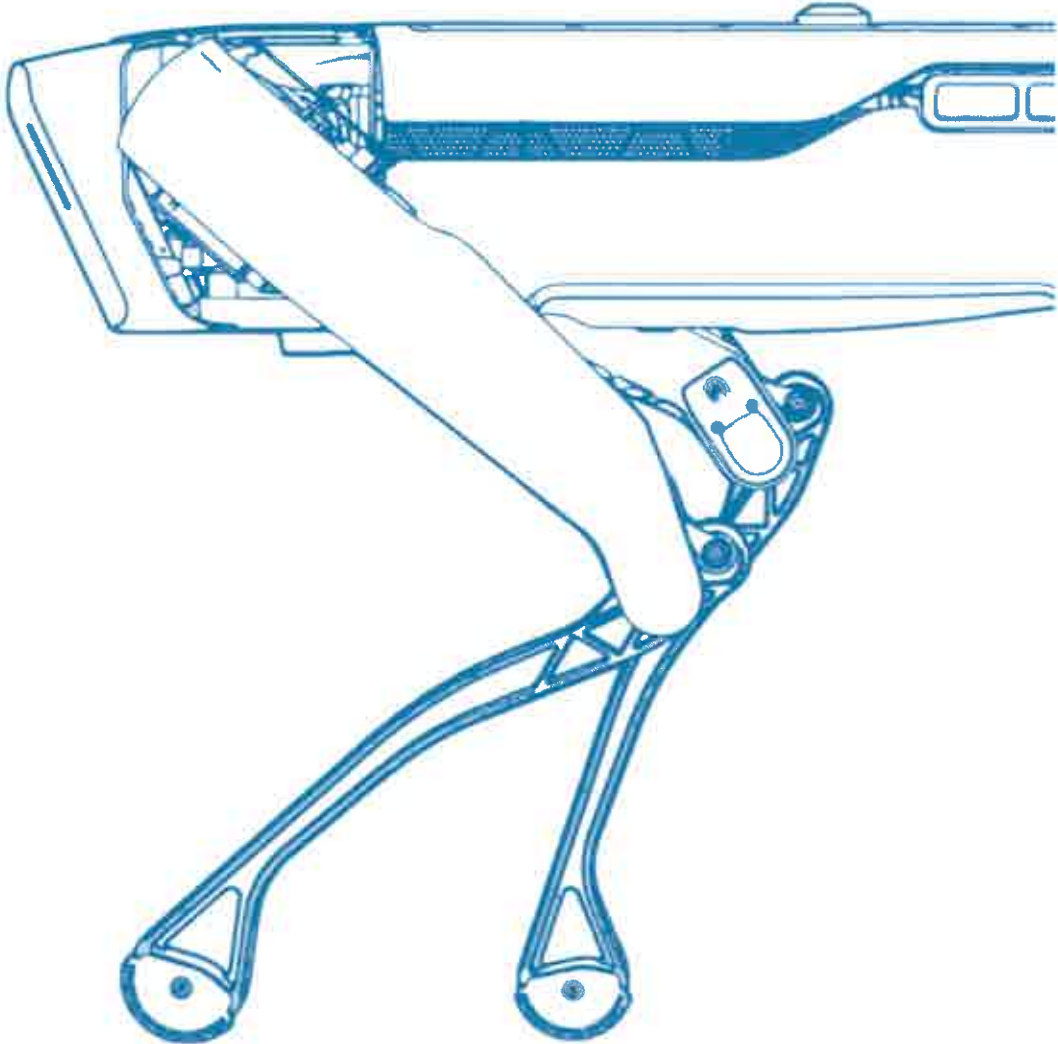



*Spot Information for Use v1.1*

© Boston Dynamics, Inc. 2021  
All rights reserved

Version 1.1  
April 2021

Boston Dynamics, Inc.  
200 Smith St.  
Waltham, MA 02451  
USA

+1 617-868-5600

[support@bostondynamics.com](mailto:support@bostondynamics.com)



# Contents

<b>1</b>	<b>Introduction .....</b>	<b>7</b>
1.1	Manufacturer information.....	7
1.2	Definition of a Spot User .....	7
1.3	Definition of a Spot Operator .....	7
1.4	Description of the machinery .....	8
1.5	Robot anatomy .....	8
1.6	Specifications .....	9
1.7	Spot Explorer and Spot Enterprise .....	10
<b>2</b>	<b>Product safety overview .....</b>	<b>12</b>
2.1	Intended use .....	12
2.2	Restrictions on the environment .....	13
2.2.1	Environmental conditions.....	14
2.3	Misuse .....	15
2.4	EMC considerations.....	16
2.4.1	Radio considerations: .....	16
2.4.2	Laser .....	16
2.5	Noise .....	17
<b>3</b>	<b>Transport, handling, and storage.....</b>	<b>18</b>
3.1	Transport .....	18
3.2	Safe handling .....	19
3.2.1	Safe conditions for handling Spot .....	19
3.2.2	Pinch points.....	20
3.2.3	Handles.....	20
3.2.4	Proper two-person lift.....	21
3.2.5	PPE.....	22
3.3	Storage .....	22

3.3.1	Battery storage .....	23
<b>4</b>	<b>Installation and commissioning .....</b>	<b>24</b>
4.1	Before starting .....	24
4.2	Preparation .....	24
4.3	Spot robot payloads .....	25
4.3.1	Qualification of notable attachments .....	26
4.3.2	Safety-related payloads.....	26
4.3.3	Mounting payloads.....	27
4.3.4	Configuring payloads.....	27
4.4	Battery setup and charging .....	28
<b>5</b>	<b>Use of the machine .....</b>	<b>30</b>
5.1	Spot controls on the robot .....	30
5.2	Robot status lights.....	31
5.3	Spot tablet controller .....	33
5.4	Starting the robot.....	33
5.5	Modes of operation.....	34
5.5.1	Obstacle avoidance .....	34
5.5.2	Navigating stairs .....	35
5.6	Stopping the robot .....	36
5.6.1	Manual stop using the controller .....	36
5.6.2	Operational stop .....	37
5.6.3	Protective stop .....	37
5.6.4	Starting back up after a stop .....	40
5.7	Turning off Spot.....	40
<b>6</b>	<b>Maintenance .....</b>	<b>41</b>
6.1	Cleaning the robot.....	41
6.2	Spot Dock connector cleaning .....	41
6.3	Recalibration with SpotCheck .....	42



**7 Emergency situations..... 43**

7.1 Fire ..... 43

7.2 Harm caused by Spot to persons or facilities..... 43

**8 Residual risks of operation.....44**

8.1 Hazardous materials..... 44

8.2 Electrical hazards: Direct/indirect contact with live parts.....44

8.2.1 Accidental exposure to high EMI or high voltage ..... 45

8.3 Non-ionizing radiation considerations..... 45

8.4 Hazards related to locomotion ..... 46

8.4.1 Accidental impacts..... 46

8.4.2 Unexpected movements during regular locomotion ..... 46

8.4.3 Potential hazards associated with stopping Spot..... 47

8.4.4 De-energized state ..... 47

8.4.5 Loss of stability and falls.....48

8.4.6 Potential contact when far from the robot..... 49

8.4.7 Residual risks with contact events..... 50

8.5 Pinch points during motion .....51

8.6 Risks associated with changes in mission profiles .....51

**9 Compliance statement ..... 52**

9.1 EU Declaration of Conformity.....52

9.2 Validity of declaration .....53

9.3 Marking .....53





# 1 Introduction

This document contains critical safety information for the Spot robot.

Responsible use of Spot is crucial to prevent dangerous conditions for operators and others nearby. Make sure to read, understand and comply with this document to lessen the risk of injuries or damage to the robot or other property.

Please read the entire document before using Spot and keep the document in a readily accessible location afterwards.

Complete user and developer documentation on the Spot robot platform is available on the [Boston Dynamics Support Center](#).

## 1.1 Manufacturer information

Spot is manufactured by:

Boston Dynamics, Inc.  
200 Smith Street  
Waltham, MA 02451  
USA

## 1.2 Definition of a Spot User

In the scope of the present document, a “User” is the entity that uses Spot for the intended use and is responsible for the personnel associated with the robot operation. Users are subject to workplace safety regulations and are active counterparts of the manufacturer in implementing residual risk reduction measures.

## 1.3 Definition of a Spot Operator

In the scope of the present document, an “Operator” is any person operating, maintaining, cleaning, or troubleshooting Spot under the responsibility of a User, including person(s) who can be reasonably expected to be near Spot, even if not directly operating the robot. Operators must be trained in the use of Spot.

## 1.4 Description of the machinery

Spot is a legged robot capable of mobility on a variety of terrains. Spot uses multiple sensors and 3 motors in each leg to navigate in indoor and outdoor environments, maintain balance and attain postures.

	<p>Refer to training and safety videos on the <a href="#">Boston Dynamics Support Center</a> for details about Spot usage and behavior.</p>
---	---

## 1.5 Robot anatomy

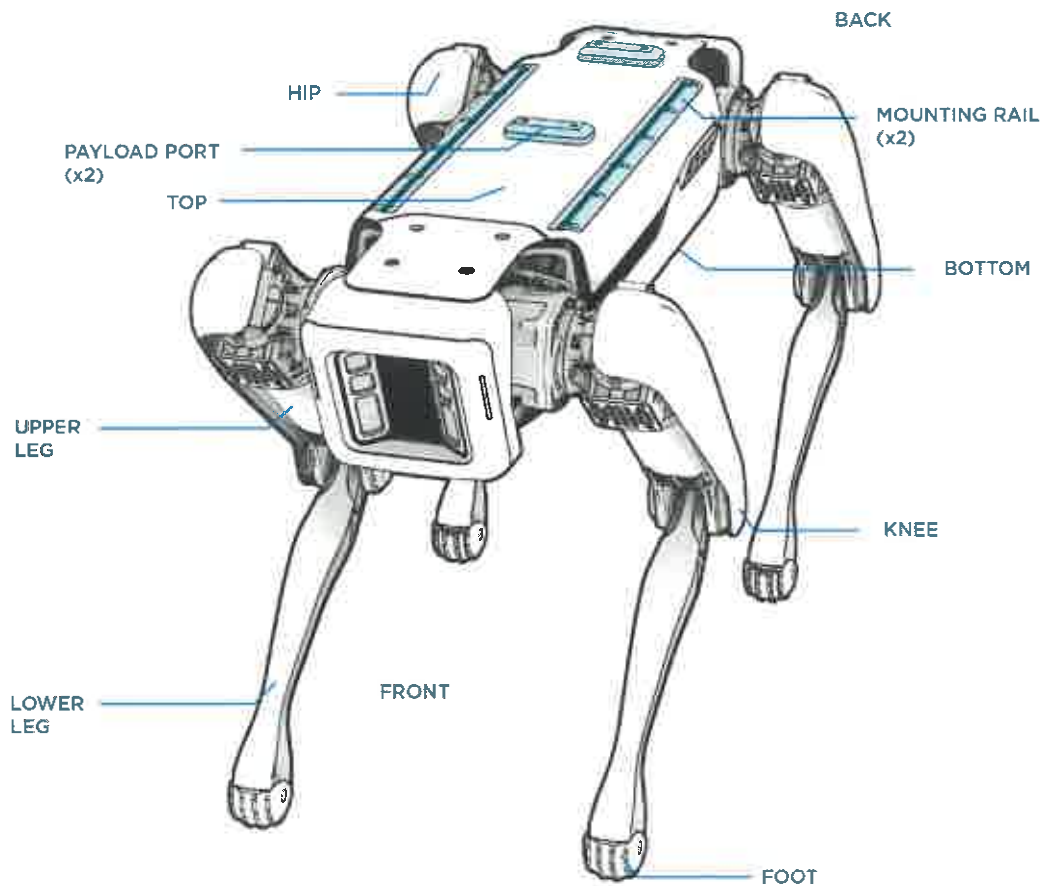



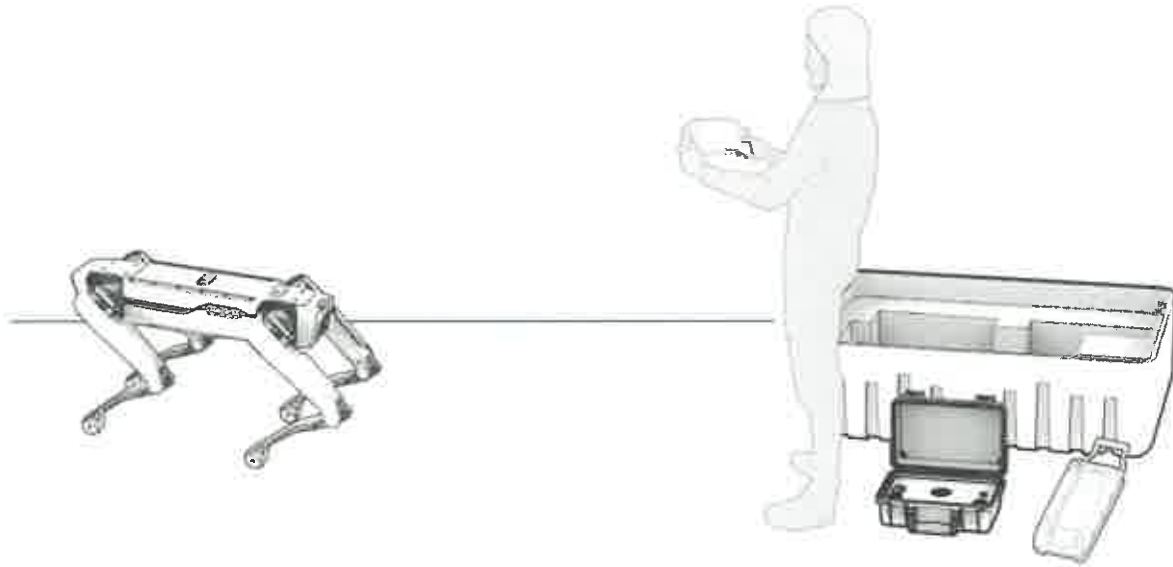

Spot robot, operator, battery charger, shipping case, and battery

## 1.6 Specifications

<p><b>Robot dimensions</b></p> <p>Length: 1100 mm</p> <p>Width: 500 mm</p> <p>Height (standing): 840 mm</p> <p>Height (sitting): 191 mm</p> <p>Net weight including battery: 31.7 kg (69.9 lbs)</p>	<p><b>Battery</b></p> <p>Battery capacity: 605 Wh</p> <p>Average runtime (no payload): 90 mins</p> <p>Standby time: 180 mins</p> <p>Recharge time: 120 mins</p> <p>Weight: 4.2 kg</p>
<p><b>Battery charger</b></p> <p>Input voltage: 100-240VAC 50/60Hz 5.5A Max</p> <p>Output: 35-58.6 VDC 7.2A Max</p> <p>Operating temperature: 0°C to 40°C</p>	<p><b>Connectivity</b></p> <p>Explorer: 2.4Ghz 802.11 b/g/n</p> <p>Enterprise: 2.4Ghz 802.11 b/g/n 5Ghz 802.11ac</p> <p>Gigabit Ethernet</p>

*Spot Information for Use v1.1*

<p><b>Terrain sensing</b>  Horizontal field of view: 360°  Range: 4 m  Lighting: &gt; 2 Lux  Collision avoidance: Maintains set distance from stationary obstacles</p>	<p><b>Locomotion</b>  Max speed: 1.6 m/s  Max slope: ±30°  Max step height: 300 mm</p>
<p><b>Payloads</b>  Payloads can be mounted on Spot using the payload rails and interfaced through payload ports.</p>	<p><b>Environment</b>  Ingress protection = IP54  Operating temperature = -20°C to 45°C  Operating Humidity – 0 to 70% RH</p>

## 1.7 Spot Explorer and Spot Enterprise

Spot has two variants: Explorer and Enterprise.

Feature	Spot Explorer	Spot Enterprise
Self-charging capability	Not available	Includes Spot Dock*
Autowalk/GraphNav	1 km total mission map limit	Unlimited mission length
Automatic diagnostic logging	No option to disable	Option to disable
Wi-Fi	2.4Ghz 802.11 b/g/n	2.4Ghz and 5Ghz 802.11 b/g/n and 802.11ac
Payload power	Always on	Toggle state via tablet or API
High-speed mission data offloading	Not available	Quickly offload mission data through Spot Dock Ethernet connectivity

\* Spot Enterprise Users and Operators should review *Spot Dock Information for Use* in the [Boston Dynamics Support Center](#) for details about Spot Dock installation and setup.





## Properties of the Spot robot:

- Spot is a self-propelled (battery powered) legged robot.
- The robot uses embedded sensors for detecting the surrounding environment.
- The robot uses a complex set of control algorithms to balance and navigate.
- Spot capability can be expanded with a variety of payloads.
- Spot does not carry persons.
- Spot is operated remotely without a physical connection such as a cable between control units and the robot.

## 2 Product safety overview

Spot is a quadrupedal, dynamically balancing robot with a sophisticated control methodology.

	<p>Spot is a mobile robot with a high degree of autonomy in locomotion. The robot's behavior while in motion can be variable or unexpected with respect to planned trajectories or movements.</p> <p>Use caution at all times when operating Spot. Carefully review the information in this document and follow all recommendations.</p>
---	--

	<p>The upright and/or balancing posture can only be attained with active control.</p> <p>However, active control does not ensure that stable balancing is attained.</p> <p>Stability is also determined by the conditions of the ground and the environment at any given time. Such conditions are not entirely predictable and Spot may fall unexpectedly.</p> <p>Use caution at all times when operating Spot. Carefully review the information in this document and follow all recommendations.</p>
---	--

	<p>Spot is a complete machine for the purpose and functions described in this chapter. Conditions for substantial modification of the machine are reported in chapter 9.</p> <p>Boston Dynamics recommends that users conduct a full risk assessment of their application.</p>
---	--

### 2.1 Intended use

Spot is intended to be used for locomotion or inspection in industrial or controlled environments, subject to limitations of conditions and preparation by the User after a



survey of the expected or planned environment.

Spot is not intended for collaborative applications involving human contact, other than during setup, configuration and environment or robot condition verification. Spot is intended to be used in dedicated areas, where access is restricted or where demarcation is made clear to Operators.

Spot may be remotely controlled by properly trained Operators, or autonomously piloted following configuration or programming by a trained professional.

Where locomotion is expected to be executed autonomously or supervised by a remote station in largely unsupervised environments, humans are not expected to be present, or are seldom or accidentally but infrequently present.

Spot is capable of carrying payloads. Payloads are attachments with dedicated purpose that can be powered by Spot and can provide a specific function, affect the robot's locomotion, or actively control Spot.

Payloads that extend or modify the intended use of Spot are outside the scope of this document and must be considered a substantial modification of the robot. See [9 Compliance statement](#).



The use of payloads and the type of control functions that are determined by payloads could result in hazards. Users must review the intended use of additional equipment attached to Spot and the effect of common control functions.

## 2.2 Restrictions on the environment

Within the scope of this document, an “industrial environment” is a workplace where non-trained or non-professional Users are restricted from access.

Industrial environments can be structured or semi-structured, provided that the layout, infrastructure and hardware inside the environment have a designated purpose. Elements of the layout or objects may be expected to be known or foreseeable by Users as part of their process.

Users are responsible for the condition of the operating environment. In particular, Users must ensure that:

- A working area for Spot has been delimited and all Operators and bystanders exposed to the robot are notified of this area before usage.

- Spot Operators and observers conform to their employer’s safety guidelines for the use of PPE.
- Access to the industrial environment is restricted to working adults who have been informed about the content of this document.
- Public spaces that fail to comply with the restriction from access and are not in control of trained operators are excluded.
- Untrained personnel and children are excluded from the industrial environment.
- Research laboratories or temporary facilities are eligible for use provided that all conditions and restrictions apply.

### 2.2.1 Environmental conditions

Environmental conditions can cause hazards when operating the robot. The environment must be prepared and checked against known limitations.

Environmental condition	Hazard
Cliff edges	<p>Spot cannot determine the extent of sudden termination of a walking surface or a negative obstacle such as a gap beyond the size of a stair step.</p> <p>Open and deep edges (“cliff edges”) must be guarded with the use of blocks, guards, nets, or other infrastructure components larger than 300 mm.</p>
Presence of sand, dust, and liquids	<p>Spot is able to walk on sand, dust, and liquids that partially cover walking surfaces. However, particularly slippery materials or round particles could compromise the robot’s stability.</p> <p>Do not operate the robot if the environment is completely or largely covered in slippery materials.</p>
Presence of cords	<p>Cords can be hard for Spot to detect and may cause tripping or entangling conditions for Spot legs.</p> <p>Clear cords and cables from the robot’s path.</p>
Transparent, mirrored or very bright surfaces	<p>Do not operate Spot on or around transparent, mirrored, or very bright obstacles.</p> <p>Transparent, mirrored/mirroring or very bright obstacles affect or hamper Spot sensors. Ensure that all surfaces in the operational environment are textured.</p>



Environmental condition	Hazard
Walking surfaces that are not stable or moving	Spot cannot rely on its sensors if ground surfaces are not stable.  Do not operate Spot on moving surfaces, such as elevators, escalators, moving walkways and ramps, vehicles, or boats.  Transportation on a moving platform is allowed if the robot is in lockout mode.
Steep inclines	Do not operate Spot on inclines exceeding +/- 30 degrees.
Excessive stair step height	Stair step and riser dimensions must be within 175 x 255-280 mm, with a maximum step of 300 mm.
Lighting	Do not operate if lighting sources provide less than 2 lux.
Operating temperatures	Do not operate when the temperature is below -20°C or higher than 45°C.

## 2.3 Misuse

The following behaviors by Operators or Operators do not correlate with any operational need for accomplishing a mission/production objective, and do not constitute an intended use:

- ❌ Entering or remaining inside a restricted area designated for Spot operations other than for the purpose of setting or recording missions
- ❌ Approaching and/or staying close to Spot during operation to observe the robot
- ❌ Attempting to access moving joints or other robot components during active Spot operations
  - Attempting to make contact with the robot during the onset of instability for modifying the course of events, including attempts to prevent falls by grabbing, holding, or propping Spot
- ❌ Transportation of persons or animals
- ❌ Transportation of hazardous materials or substances
- ❌ Intentionally harming any person with the robot or by using payloads mounted on the robot
- ❌ Use for any illegal purpose



## Spot Information for Use v1.1

- Use as a climbing aid
- Use in potentially explosive environments
- Use outside the restricted environmental conditions

	Any robot misuse can potentially cause severe personal injuries or result in significant material hazards.
---	--

## 2.4 EMC considerations

Spot has been tested for EMC compliance according to standards related to heavy industrial environments. Spot should be able to withstand EMC disturbances typically found in industrial environments.

	Use of Spot in environments with EMC disturbances greater than those tested for can result in erratic and uncontrolled behavior from Spot.
--	--

Spot has been tested in accordance with the Industrial EMC test standards EN IEC 61000-6-4 and 61000-6-2.

### 2.4.1 Radio considerations:

Spot uses a Wi-Fi radio that has been approved to the Radio Equipment Directive (RED). In addition, Spot has been evaluated in accordance with the appropriate RED standards for radio devices.

### 2.4.2 Laser

The Spot robot contains five stereo camera systems that contain a Class I laser projection system.



	<p>This product is classified as a Class 1 Laser Product under the EN/IEC 60825-1, Edition 2 (2007) and Edition 3 (2014).</p>
--	---

	<p>Do not tamper with or make adjustments to any of the laser components in the Spot robot. Doing so may result in hazardous radiation exposure. Use of controls or adjustments or performance of procedures other than those specified herein may also result in hazardous radiation exposure.</p>
--	---

## 2.5 Noise

The airborne noise generated by Spot is determined by the environment Spot is operating in.

The noise of Spot walking across a padded carpet floor will be much less than the noise from Spot walking up metal stairs. Before putting Spot into regular use, Users should work with their EH&S staff to determine if additional PPE is required due to the noise generated by Spot in its working environment.

## 3 Transport, handling, and storage

### 3.1 Transport

Spot is transported in two customized cases designed exclusively for the robot and its associated components.

<b>NOTICE</b>	Do not discard the cases after removing Spot. The cases are designed for transporting the robot and its accessories, and for returning them to Boston Dynamics for service.
---------------	---

<b>Shipping case for the robot</b>	<b>Shipping case for battery pack/power supply</b>
Length: 927 mm	Length: 559 mm
Width: 546 mm	Width: 432 mm
Height: 464 mm	Height: 267 mm
Empty container: 47.6 kg	Empty container: 9.2 kg
Combined weight: 80.1 kg	Combined weight (one battery): 18.1 kg
	Combined weight (two batteries): 22.7 kg





## 3.2 Safe handling

Operational and safety instructions about handling Spot are collected in a series of training videos.

	<p>Details and illustrated procedures are collected in a series of training videos on the <a href="#">Boston Dynamics Support Center</a>:</p> <ul style="list-style-type: none"><li>• Spot Safety: Safe Handling</li></ul> <p>Pay careful attention to the following items:</p> <ul style="list-style-type: none"><li>• Safe conditions for handling (check that power is off)</li><li>• Pinch points (locate them and learn how to appropriately lift the robot)</li><li>• Handles (locate them and learn how to lift the robot)</li><li>• Proper two-person lift (illustrated procedure)</li></ul>
--	--

For details about Spot Dock safe handling, refer to *Spot Dock Information for Use* in the [Boston Dynamics Support Center](#).

### 3.2.1 Safe conditions for handling Spot

There are two safe handling conditions for the robot:

- Power OFF
- Power ON, motor lockout

Refer to [5.6 Stopping the robot](#) for information about safely powering down the robot.

	<p>Lifting the robot without powering off the robot will result in unexpected motion, as the robot will attempt to control its balance. Only handle Spot when the motors are locked out or the robot is powered off.</p>
--	--

### 3.2.2 Pinch points

Spot's joints can pinch fingers and other body parts and entangle loose clothing, long hair, and jewelry.

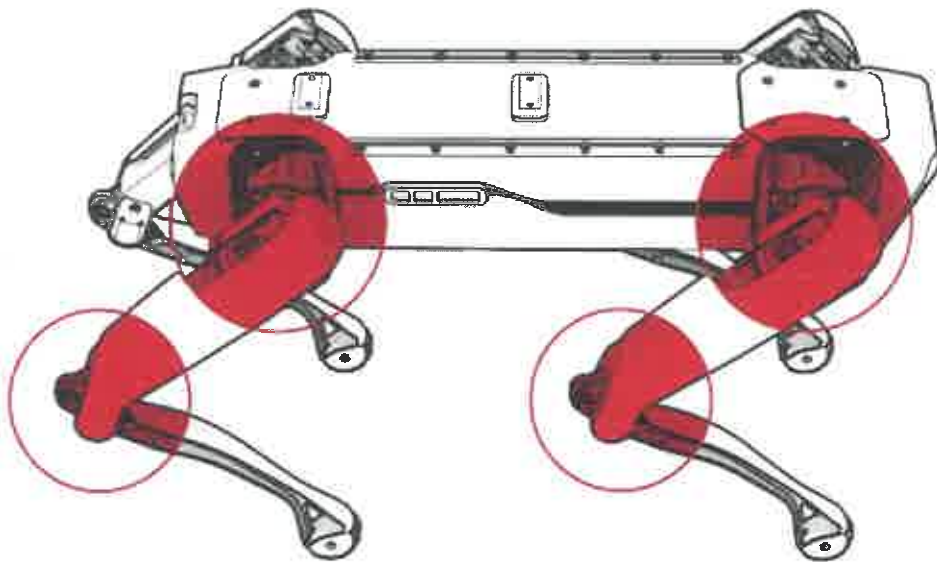

Pinch point risk zones

### 3.2.3 Handles

Spot has a handle at each hip joint. Use these to lift, carry, and roll the robot.

 <b>WARNING</b>	<p>Always keep hands away from knee joints. Use caution when lowering Spot or closing the legs.</p> <p>Always keep hands away from hip joints, except when grabbing handles. Always make a fist when gripping handles to keep your fingers away from pinch points.</p> <p>When using the handles, hands and fingers may be pinched.</p> <p>Always make a fist with each hand. Do not extend the fingers to avoid potential pinch hazard.</p>
--	--

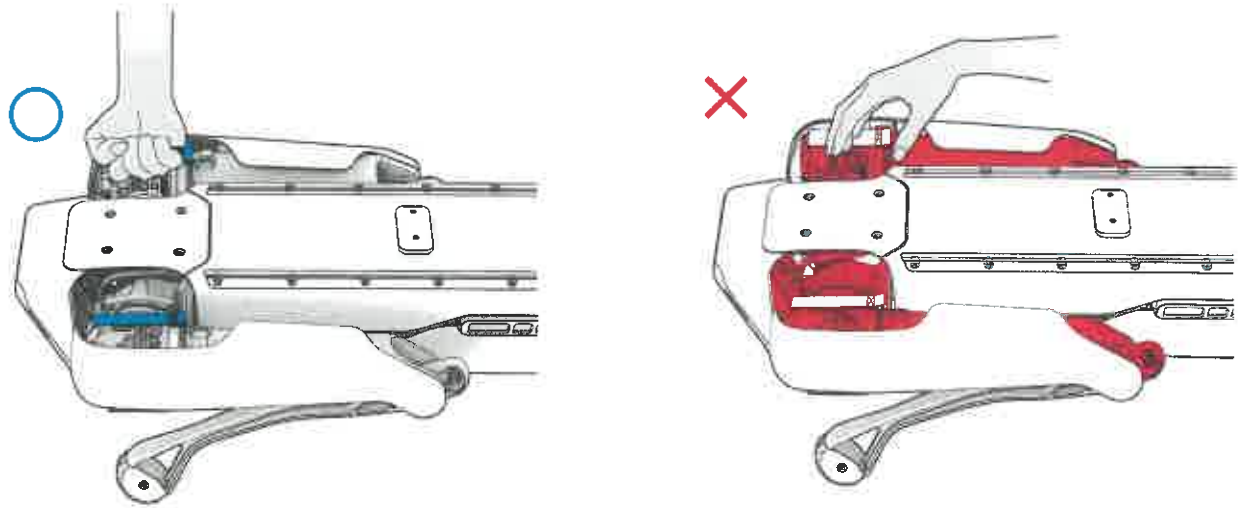

Use grasp handles to avoid pinch points

 <b>WARNING</b>	To avoid pinch points, never carry Spot with fingers extended.
--	--

### 3.2.4 Proper two-person lift

Spot is heavy (32 kg) and can be awkward to carry, particularly with attached payloads. Grab the handles and maintain safe lifting precautions. Always use two people to lift Spot, one at the front and one at the rear.

	Details and illustrated procedures are collected in a series of training videos on the <a href="#">Boston Dynamics Support Center</a> :
	• Spot Operation: Spot Startup
	In this video, please pay careful attention to the following items:
	• How to lift Spot with two persons • Safest grabbing points for loose legs (end segment) • Use of handles at the hips

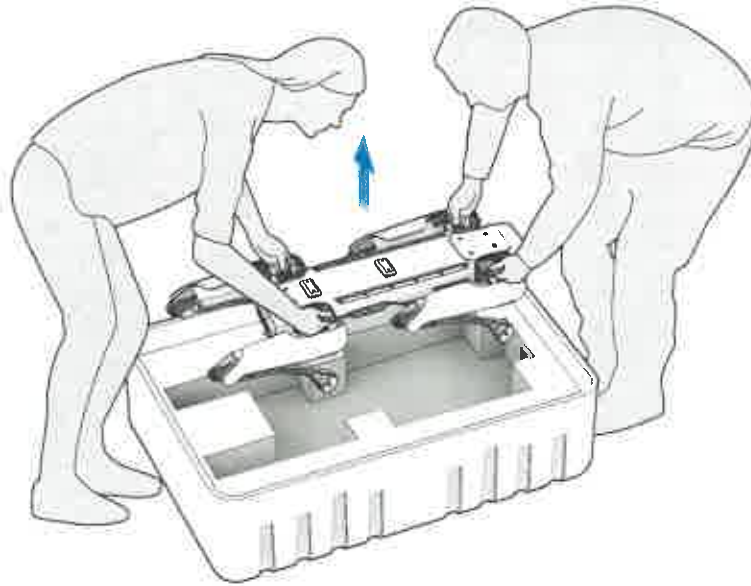

**Two-person lift**

### 3.2.5 PPE

While handling Spot, no additional PPE is needed other than what is required for Operators in their industrial environment. However, it is recommended to wear safety footwear.

### 3.3 Storage

Store Spot in a dry location that has adequate temperature controls. Spot can be safely stored in temperatures between -30°C and 40°C, with relative humidity between 30% and 70%.



### 3.3.1 Battery storage



Details and illustrated procedures are collected in a series of training videos on the [Boston Dynamics Support Center](#):

- Spot Safety: Battery and Charging

In this video, please pay careful attention to the following items:

- How to remove and check batteries by carefully inspecting the battery slot
- How to handle the battery

- Store at -30°C to 25°C.
- Spot Users should develop a battery storage and charging safety policy consistent with industry standards and local regulations.
- Remove battery from robot during transportation or storage.

#### **NOTICE**

When not in use, remove the battery pack from Spot. Boston Dynamics recommends storing Spot in the transportation case provided with the robot.



## 4 Installation and commissioning

Because Spot is a mobile robot, it does not require any special structural hardware or installation fixtures such as special anchoring mechanisms, anti-vibration pads, etc.

### 4.1 Before starting

It is the User's responsibility to ensure that Operators, bystanders and all exposed persons are trained in safe behavior around Spot and that the operation of Spot does not put anyone at risk.

Spot Enterprise Users and Operators should review *Spot Dock Information for Use* in the [Boston Dynamics Support Center](#) for details about Spot Dock installation and setup.

	All operators (personnel either exposed to Spot, actively using the robot, or observing) are subject to hazards.
---	--

Spot is not intended to be used for tasks that require operation in close proximity to people.

### 4.2 Preparation

General instructions about Spot setup are illustrated in a series of training videos.

	Details and illustrated procedures are collected in a series of training videos on the <a href="#">Boston Dynamics Support Center</a> : <ul style="list-style-type: none"><li>• Separation distances from Spot</li><li>• Spot set up and safe handling</li></ul>
---	--

	Before setting up Spot, ensure there is enough clearance around the robot to safely operate. Prepare the robot on a flat, stable and clean surface. Check the availability of a separation distance of at least 2 m from Spot before operation.
---	---



### 4.3 Spot robot payloads

Payloads are attachments that can be fixed to the mounting rails. Power and data interfaces are available through payload ports.

Payload type	Properties
Passive payloads	Non-actuated attachments, used for sensing and signal processing, powered by Spot power supply (battery).
Active payloads	Attachments that incorporate actuated motion separate from the motion of Spot. Active attachments can be controlled independently or via data interfaces, powered by Spot power supply (battery) or separate source.
Radiating payloads	Radiating is defined as radio-frequency (RF) or optical energy. RF emitters are devices such as radio transmitters (Wi-Fi, Bluetooth, etc.) or digital devices that unintentionally radiate. Optical radiators are lasers or LED devices capable of providing optical energy greater than class I limits as defined in IEC 60825-1:2014



Spot has been tested to IEC EMC Industrial standards. Payloads that emit radiation in excess of the levels Spot has been tested to may cause harm to the robot and degrade Spot's performance in a manner which is dangerous.

Boston Dynamics is not responsible for any damage caused by radiating payloads.

### 4.3.1 Qualification of notable attachments

<b>Payload properties</b>	<b>Payload type</b>
Attachments with minor movements that have negligible effect on the geometry, motion envelope, and mass distribution of payloads: for example, small pan and tilt cameras or rotary scanners	Passive payloads
Attachments that provide safeguarded input or emergency stop devices	Passive payloads
Attachments that have a direct effect on Spot control and behavior via signal or power interfaces	Active payloads
Spot Arm	Active payloads
All Boston Dynamics payloads	Passive payloads

### 4.3.2 Safety-related payloads

The following types of payloads may change the intended use of Spot. The resulting robot system made up of Spot and payload must be considered a different product/function or application:

- ❖ All active payloads
- ❖ Passive, active, and radiating payloads that are interfaced with external equipment via data channels or signals and can trigger functions on external equipment
- ❖ Radiating payloads that do not comply with the regional EMC or laser safety requirements for industrial environments

Spot with safety-related payloads must be put in service in accordance with the regulations of the country where Spot is used.



Adding any safety-related payloads to Spot requires that a full risk assessment be performed.

With the addition of any safety-related payload, Spot is no longer in scope of the Declaration of Conformity issued by Boston Dynamics. The User will be responsible for conducting a risk assessment and verifying continued conformity with applicable safety, machinery, EMC and radio standards. See [9 Compliance statement](#).

### 4.3.3 Mounting payloads

Spot payload weight is limited to 14 kg.

To review complete information about payload mounting requirements please visit:

- The [Payload Developer Guide](#) in the [Spot SDK](#)
- The [Boston Dynamics Support Center](#)

Combinations of payloads must not exceed the total admissible weight of 14 kg.



Loading Spot with heavier payloads may be tolerated by Spot for short periods of time and do not generate immediate (hazardous) effects. Failures due to exceedingly heavy payloads, like falls or unexpected movements, could occur unexpectedly.



Mounting passive payloads on Spot may affect the robot's stability. Payloads need to be validated and tested before use.

### 4.3.4 Configuring payloads

Refer to Spot payload documentation in the [Boston Dynamics Support Center](#) for detailed information about configuring payloads.

 <b>WARNING</b>	Incorrectly configuring payload parameters may cause failures in balancing and potential loss of stability.
--	---

	Refer to Spot payload documentation in the <a href="#">Boston Dynamics Support Center</a> for more information and in the <a href="#">Spot SDK documentation</a> .
---	--

#### 4.4 Battery setup and charging

Spot is powered by a removable lithium-ion battery pack. The battery can be charged standalone using the robot's battery charger or while installed in the robot.

The robot's battery must be removed from the robot when not in use.

 <b>WARNING</b>	Don't short-circuit, burn, disassemble, submerge, puncture, crush, drop, or damage the battery. If a battery fire starts, do not try to put it out. Evacuate to a safe area and call the fire department. Battery fires create toxic fumes and cannot be put out with conventional fire extinguishers or water.
--	--

Only charge the battery with the charger provided by Boston Dynamics.



With Spot on its back, slide the battery's non-handle side into the rear of Spot's battery compartment and latch the handle. Ensure the battery is properly latched.

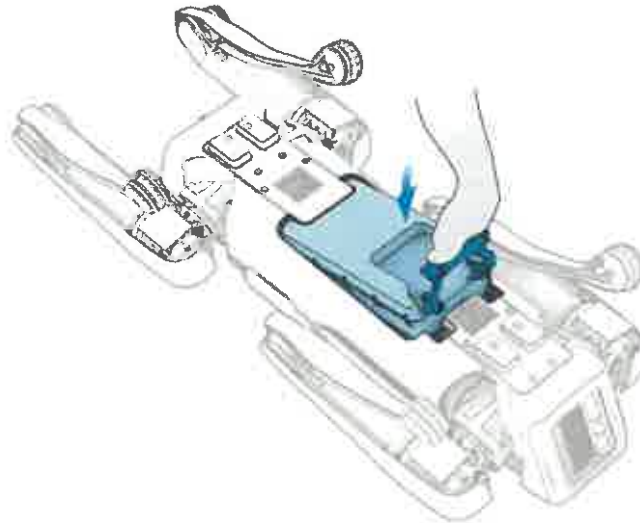

### Inserting the battery



To reduce the risk of electric shock and fire:

- Use a properly grounded outlet. Do not use ground adapters or replace plug.
- Do not touch uninsulated parts of the output connector or battery terminals.
- Do not open or disassemble the charger.
- Do not use if the AC cord is damaged.

Operate the charger in the following conditions:

- Charge at: 0°C to 40°C
- Input: 100-240 VAC, frequency 50/60Hz, Current 5.5A
- Max Charge time: 2.5 hours



Details and illustrated procedures are collected in a series of training videos on the [Boston Dynamics Support Center](#).

- Battery safety and storage
- Battery Installation
- Additional charging instructions

## 5 Use of the machine

### 5.1 Spot controls on the robot

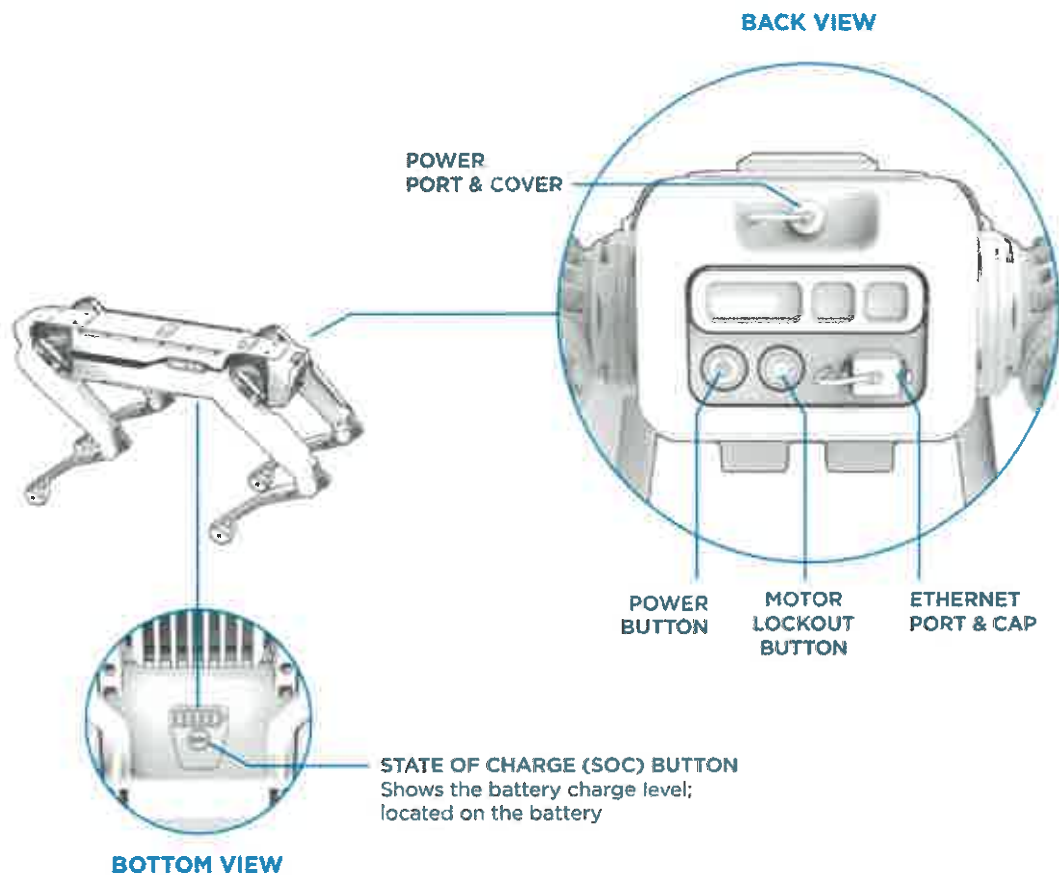

Spot battery and power controls



## 5.2 Robot status lights

The robot's LED status lights are located on the front of the robot.

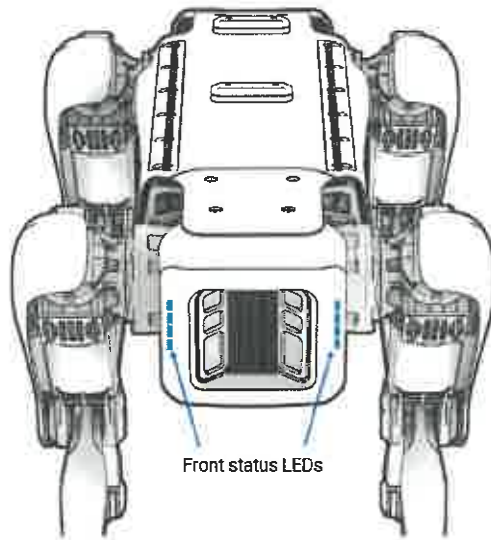

Robot's LED status lights

### MOTORS



**Solid blue:**  
Lockout button engaged;  
Spot is safe to handle



**Slow blink green:**  
Spot connected; motors may turn on



**Fast blink green:**  
Motors turning on!



**Solid green:**  
Motors on

### POWER



**Yellow:**  
System booting up



**Moving rainbow:**  
Powered on, ready to connect



**Solid rainbow:**  
Plugged in, no battery



**Rainbow dots:**  
Charging, dots show % charge

### ERRORS













**Blinking orange:**  
Serious error or perception fault  
has occurred; operation degraded



**BACK VIEW**



**POWER AND MOTOR LIGHTS**

POWER BUTTON	LOCKOUT BUTTON	ROBOT STATUS
		<b>NO LIGHTS:</b> Robot and motors off (lockout engaged)
		<b>BLUE LIGHT:</b> Computers on, motors off (lockout engaged)
		<b>SLOWLY FLASHING RED LIGHT:</b> Motors available but not powered
		<b>QUICKLY FLASHING RED LIGHT:</b> Motors turning on
		<b>SOLID RED LIGHT:</b> Motors on - stay at least 2m away

	Details and illustrated procedures are collected in a series of training videos on the <a href="#">Boston Dynamics Support Center</a> .
---	---

<b>NOTICE</b>	When the robot is powered up, no motion command is enabled, and the robot does not move.
---------------	--

There can be additional power up procedures for Spot payloads installed on the robot and which use one of the two payload ports on the robot's back.



### 5.3 Spot tablet controller

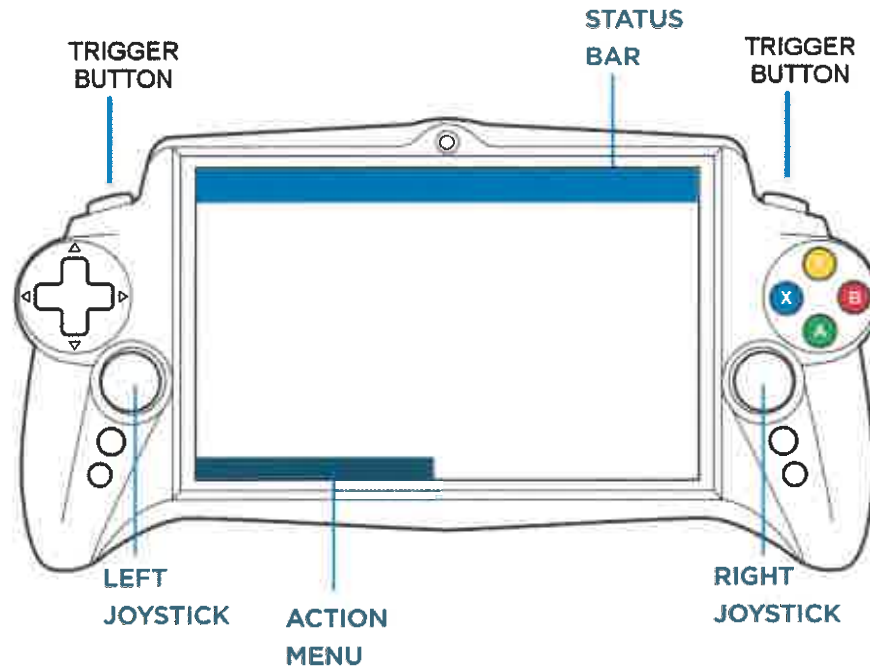

Spot tablet controls

### 5.4 Starting the robot

Before powering up the robot, make sure that Spot:

- Has a charged battery
- Is unplugged from power and Ethernet
- The power plug cover and Ethernet cover are inserted
- Is at least 2 m away from people and obstacles

To start the robot:

1. Press and hold Power button for two seconds.
2. Fans will turn on and spin loudly. Wait until fans turn off and the status rainbow lights start blinking. This takes approximately two minutes.

## 5.5 Modes of operation

	Refer to training and safety articles and videos on the <a href="#">Boston Dynamics Support Center</a> for details about operation, configuration, and programming.
---	---

Spot can be operated in various modes.

- **Manual:** Within line of sight using the tablet controller. Spot and surroundings are seen directly.
- **Teleoperation:** Allows operation of Spot beyond line of sight by displaying images from Spot's cameras on the controller.
- **Autowalk:** Autowalk missions can be recorded and replayed by the robot. During replay the robot operates autonomously.

	Details and illustrated procedures are collected in a series of training videos on the <a href="#">Boston Dynamics Support Center</a> . <ul style="list-style-type: none"><li>• Taking Spot for a walk</li><li>• Stay Spot, stay</li><li>• Spot on stairs</li><li>• How Spot sees the world around it</li></ul>
--	---

### 5.5.1 Obstacle avoidance

Spot uses its perception system to automatically avoid collisions with obstacles. The perception system consists of five stereo cameras that provide the robot with a 360 degree field of view and a detection range up to 4 m.

For details about configuring obstacle avoidance, please refer to articles in the [Boston Dynamics Support Center](#).

	Spot can collide with Operators or objects, even with its obstacle detection system enabled. Operators and anyone nearby should assume that Spot may move unexpectedly at any time.
---	---



## 5.5.2 Navigating stairs

Stairs are hazardous areas. Users must restrict access to areas with stairs as much as practically possible and mark the areas with visual signs.

When teleoperating Spot on stairs or recording an Autowalk mission that includes stairs, follow these instructions for safely climbing and descending stairs:

1. Use the controller to switch Spot to Stairs gait.
2. Position Spot at the base of the staircase.
3. Use the left joystick to walk Spot straight up the stairs.
4. To descend stairs, always operate Spot in reverse, descending rearward first.

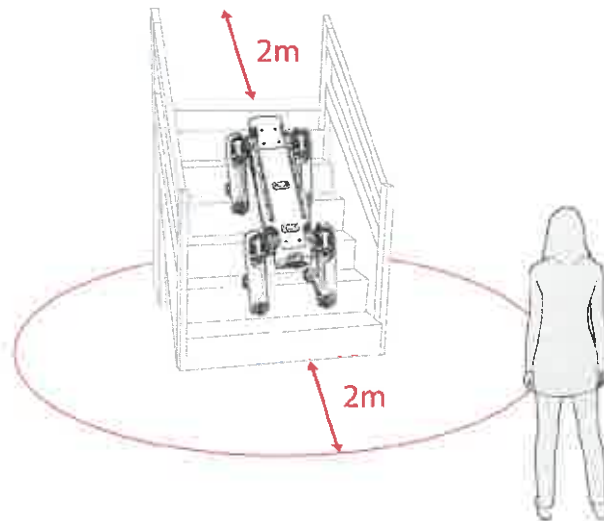

Stair safety

Visit the [Boston Dynamics Support Center](#) for detailed documentation on operating Spot robots on stairs.

The following conditions and/or actions are critical for safe stairway navigation whether teleoperating the robot or recording/replaying an Autowalk mission:

- ⚠ Grated stairs, open-riser stairs, or partially transparent stairways pose significant perception challenges during stair locomotion.
- ⚠ The robot should always descend stairs rearward-first.

	<p>Spot could fall from stairs and cause personal injuries or material hazards.</p>
	<p>Do not stand below Spot.</p>
	<p>When teleoperating Spot or recording a mission:</p>
	<ul style="list-style-type: none"><li>• Avoid turning on stairs</li><li>• Do not attempt to climb stairs by side-stepping</li><li>• Wait for the robot to reach a complete landing and secured zone before turning</li></ul>

## 5.6 Stopping the robot

### 5.6.1 Manual stop using the controller

To suspend robot motion, press the B button on the controller to stop Spot. The robot will pause and stand in place. If Spot is seated, it will remain seated.

To de-energize the robot motors:

1. Press the controller trigger buttons and the B button simultaneously.

OR

2. Select the red STOP button in the controller's top right corner. The robot will immediately sit down.





When STOP is commanded and confirmed, it takes precedence over all active commands on the controller. Motors cannot be turned on until STOP is canceled.

### 5.6.2 Operational stop

Spot monitors its sensors and can automatically pause movement or remove power from motors in certain situations:

- **Signal loss:** After 3 seconds without controller communication, Spot will sit. After 8 seconds without communication, Spot will turn off its motors.
- **Fall detection:** When Spot detects a fall, motors are immediately de-energized. Legs will not actively flail or remain stiff under contact.

	<p>Spot can detect falls that unexpectedly occur. De-energization of legs during falls minimizes damage from the fall and prevents new or bigger hazards, such as further stumbling. This behavior is called “smart freeze.”</p>
--	--

### 5.6.3 Protective stop

Spot can be stopped by interfacing an external safeguard signal to the payload port.

The stopping function will result in a de-energization of all motors (Stop Cat. 0 EN IEC 60204-1).

	<p>The robot will lose its ability to stand and balance. On flat grounds, Spot will lower its body. On inclined surfaces or stairs, Spot may tip-over.</p>
--	--

The maximum response time for the stopping function is 200 ms.

Safe inputs for activating and triggering the stopping functions are located on the payload ports as follows:

Spot Information for Use v1.1

Item	Description
Safe input location (See figure below)	I1 = pin 19
Interface	<p>Use only one port, either front or back. See example in figure below.</p> <p>Spot will not work without a cap or a properly configured payload attached to each port.</p> <p>When a cap is used, the stopping function is disabled.</p>
Safe input default connection	6-19 pair normally closed (NC)
Type of stop	Stop Category 0 (IEC 60204-1) when contact on I1 is opened.
Stopping safety function	<p>Implemented in accordance with ISO 13849-1:2016, of Category 1 and performance level c.</p> <p>The PFHD is 1.1E-6/hr.</p>
Reset	6-19 pair is closed
Restart	Enable power following commands on the manual controller or issued from programs.
Environment	The safety-related part of the control system operates within the same environment limits established for the robot.

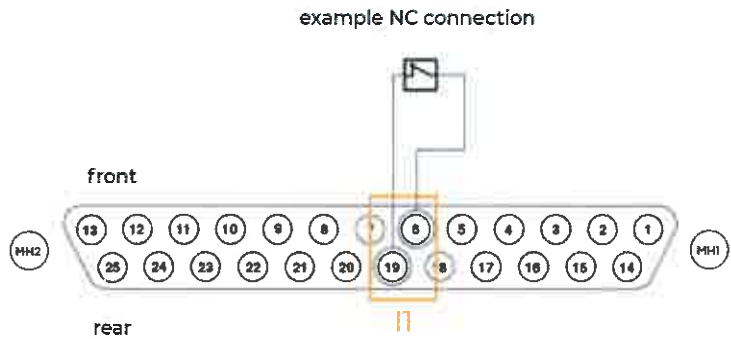
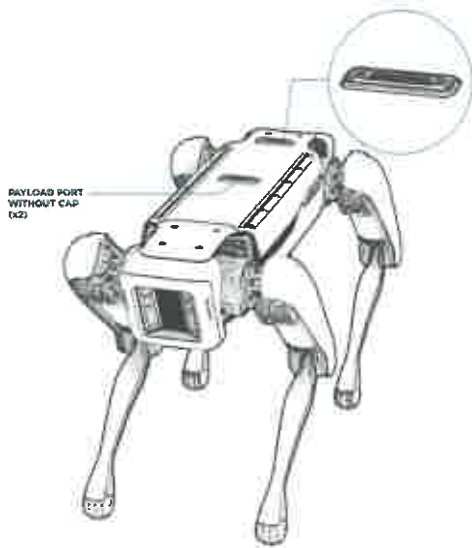

**Payload port external signal interface for protective stop**

<b>WARNING</b>	Use safety-related inputs only for connection to safeguards or emergency stop devices. Do not interface with non safety-related signals.
----------------	--



## 5.6.4 Starting back up after a stop

To resume operation after a stop:

1. First make sure safety conditions are met, and sufficient clearance is maintained.
2. Repeat the startup procedure.
3. If Spot continues to stop unexpectedly, contact Boston Dynamics Support.



Details and illustrated procedures are collected in a series of training videos on the [Boston Dynamics Support Center](#):

- Separation distances from Spot
- Spot Startup procedure

## 5.7 Turning off Spot

When ready to turn off Spot, follow this procedure:

1. Walk Spot manually using the controller to a charging, storage, or transport location. Walk Spot instead of carrying it whenever possible.
2. Sit Spot.
3. Power off motors with the controller.
4. Engage the lockout button.
5. Power off the robot by pressing and holding the blue button at Spot's rear for two seconds.
6. Select the controller's Disconnect option.
7. Connect the robot to shore power.
8. If not using shore power, remove the battery.



Details and illustrated procedures are collected in a series of training videos on the [Boston Dynamics Support Center](#):

- Spot Operation: Spot Shutdown Procedure



## 6 Maintenance

Spot is not meant to be repaired by Users. If errors or other issues persist after rebooting the robot, the robot may need attention by Boston Dynamics Support engineers. Do not attempt to service the robot yourself. Contact Boston Dynamics Support.

Email [support@bostondynamics.com](mailto:support@bostondynamics.com). Please include the following information when contacting Support:

- Robot serial number
- Description of the issue

While conducting cleaning or reboot operations, make sure to maintain a safe distance from Spot.

Review robot maintenance articles in the [Boston Dynamics Support Center](#).

### 6.1 Cleaning the robot

- Robot exterior: Use a mild detergent to clean Spot's exterior. Do not use strong solvents. Only clean when the robot is off.
- Robot cooling fans: Periodic inspection of the robot's condition may indicate that the cooling fans on the robot's underside need to be cleaned. If the fans are clogged with dirt, an overheating fault may be generated.

### 6.2 Spot Dock connector cleaning

Enterprise Users should periodically check the Dock contact points on the underside of the Spot robot. Make sure this area is clean and free from debris. If any damage has occurred in this area, please contact Boston Dynamics Customer Support.



Do not inspect or clean the robot while it is powered on. Turn off before touching the robot or performing maintenance inspections.

### 6.3 Recalibration with SpotCheck

Robot falls and ordinary usage over time can cause the robot's onboard cameras to lose calibration. If the robot starts running into obstacles that it had previously avoided, SpotCheck can evaluate and resolve camera calibration issues to restore perception accuracy.

Any of the following behaviors may be a sign that recalibration is necessary:

- The robot limps or stumbles more than usual.
- The robot runs into obstacles it has successfully avoided in the past.
- The robot has more difficulty on stairs than usual.

To return the robot to normal operation, run SpotCheck.

	Prepare a dedicated restricted area for executing SpotCheck. Review the calibration procedure. Spot movements during SpotCheck may be different from those experienced during normal operations.
---	--

	For detailed instructions, refer to Spot system administration documentation in the <a href="#">Boston Dynamics Support Center</a> .
---	--



## 7 Emergency situations

Emergency situations include fire, harm to people or facilities, or other dangerous threats or results. In the event of an emergency situation, contact your local emergency services. Please also notify Boston Dynamics.

### 7.1 Fire

In the unlikely event of a fire, a fire extinguisher rated for use on lithium ion batteries must be used. If the battery is damaged and liquid leaks out, do not attempt to handle it. Contact your local fire department for help immediately.

### 7.2 Harm caused by Spot to persons or facilities

In the unlikely event that Spot damages property or causes bodily harm to a person, please follow your local EH&S (emergency response) policies and procedures and make sure that your EH&S staff report the incident to Boston Dynamics at our customer care contacts.

## 8 Residual risks of operation

Risks are reduced by the manufacturer whenever possible and practicable.

This section identifies and explains the residual risks to Users of the Spot robot, and to observers and bystanders who may be near the Spot robot while it is being operated or recharged.

Users are advised to perform their own risk assessments.

### 8.1 Hazardous materials

There are no known significant risks associated with lubricants.

The battery pack contains cells that have electrolytes. All cells are fully enclosed in a sealed enclosure that has passed UN 38.3 transportation testing. In addition, the pack has CB Certification to IEC 62133 and has passed drop testing with no leakage of electrolyte.

	In the unlikely event of damage with visible breakage of any part of the robot or batteries, DO NOT touch or attempt any recovery.
---	--

### 8.2 Electrical hazards: Direct/indirect contact with live parts

	Do not touch or operate the robot if any damage is noticed. Contact Boston Dynamics Support.
---	--

There are no known significant residual risks associated with direct and indirect contact with live parts as a result of the adoption of the extra low-voltage (SELV) power supply design (requirements in IEC 60204-1 for electrical equipment and IEC 62133 for batteries).



Foreseeable condition	Expected outcome	Residual risk	Instructions
Ungrounded outlet	Potential exposure to high voltage in the event of an internal fault which in turn puts the voltage on the product chassis.	Electrical shock and/or fire	Only use a properly grounded outlet.
Damaged power cord	Risk of contact with uninsulated high voltage wires. Risk of electrical fire with high voltage in contact with materials in the surrounding area.	Electrical shock and/or fire	Replace power cord with one that is not damaged.
Visible damage to battery charger	If the case is damaged, it is possible that a person could contact internal high voltage circuitry.	Electrical shock and/or fire	Do not use damaged charger. Please contact Boston Dynamics for a replacement.

### 8.2.1 Accidental exposure to high EMI or high voltage

Spot has been investigated to operate and perform normally in environments where EMI fields and high voltage operation is not a known source of hazards to workers in the area.

### 8.3 Non-ionizing radiation considerations

There are no known significant residual risks associated with non-ionizing radiation. Risks are reduced by design using components compliant with relevant technical standards (IEC 60825-1 for Class I LASERS, CISPR 32:2012 and CISPR 11:2009/A1:2010 for EMI).

## 8.4 Hazards related to locomotion

Spot is a legged robot. Locomotion and balance is based on a dynamic control principle. Sensors are used for the perception of the ground and the surrounding environment.

The conditions of the environment have a significant influence on the robot's stability and the possibility of failure during locomotion.

	<p>Hazardous conditions during locomotion could result in the following behaviors:</p> <ul style="list-style-type: none"><li>• Falls</li><li>• Instability and recovery attempts that cause unpredictable movements of the legs</li><li>• Large deviations from planned and expected paths</li><li>• Sudden accelerations of either the legs or the entire robot</li><li>• Tipping over</li><li>• Sliding or tumbling following a fall or tip over</li><li>• Any combination of the above</li></ul>
---	---

### 8.4.1 Accidental impacts

Impacts are not expected in the normal intended use of Spot in restricted areas. Residual risks are associated with unexpected movements or falls. While the residual risks are located in proximity of the robot, some robot falls could generate risks at a further distance.

### 8.4.2 Unexpected movements during regular locomotion

Spot uses a sophisticated control methodology to dynamically balance and navigate using perception from sensors. The robot's behavior while in motion can be variable or unexpected with respect to planned trajectories or movements already observed in similar conditions or during previous executions of the same operations.

- ✱ When the environment presents narrow passages, corners or cluttered layouts combined with ground obstacles, Spot could use high-speed movements to maintain or regain balance. Spot could accelerate in a direction different from the main locomotion direction.
- ✱ When being paused, the sudden appearance of an obstacle could cause Spot to move away from the obstacle to maintain a sufficient or predetermined separation distance. Spot could accelerate in a direction different from the main locomotion direction.



- When traversing stairs or uneven surfaces, Spot could accelerate in any direction or change body attitude in an attempt to maintain its balance.

Spot is not able to move faster than a person in normal conditions (considering the generic ISO 13855 velocity of 1600 mm/s for human operators).

	<p>Use caution at all times when operating Spot.</p> <p>DO NOT enter or stay inside designated restricted areas.</p> <p>DO NOT stay within 2 m of Spot.</p> <p>Check the availability of sufficient clearances if inadvertently within 2 m of Spot.</p>
--	---

#### 8.4.3 Potential hazards associated with stopping Spot

Stopping Spot removes actuation energy to its motors. Spot will attempt to lower its body under gravity before de-energization.

	<p>Energy removal from leg actuators would cause the loss of balancing capability (balancing is only possible under active control). A stopping event may cause the loss of stability and potential hazards associated with falls or tipping over. Always keep a separation distance of 2 m.</p>
--	--

#### 8.4.4 De-energized state

As a consequence of the balancing locomotion principle, legged robots may not immediately reach a de-energized steady state upon energy removal (e.g., cut motor power).

Automatic de-energization of motors will cause some residual motion to reach a steady state. The extent of residual motion depends on:

- The orientation of Spot (body attitude and configuration of legs)
- Ground conditions (surface, inclination and geometry)



For instance, on a flat surface, a de-energization event would likely cause a vertical collapse event. On a slope, and depending on the attitude and position of legs/feet, a de-energization event could cause a tip-over falling event.

#### 8.4.5 Loss of stability and falls

The upright and/or balancing posture can only be attained with active control. However, active control does not ensure that stable balancing is attained.

Stability is also determined by the conditions of the ground and the environment at any given time. Such conditions are not entirely predictable and Spot may fall unexpectedly.

The fundamental outcomes of a loss of stability are:

- A sudden, mostly vertical collapse of the robot: (a) in the figure below.
- A tip-over on a predominantly flat surface, which rarely results in more than a half turn. Legs can extend by effect of inertia when motor power is disabled in the event of failure or fall: (b) in the figure below.
- A tip-over on an inclined surface, which can result in further turns and accidental motion without power: (c) in the figure below:

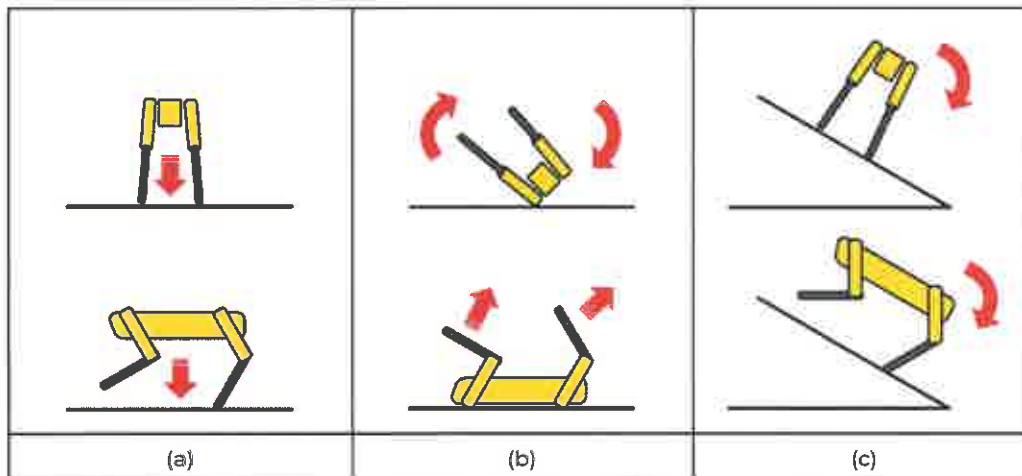

Spot is not intended to be used in close proximity to Operators, observers, or bystanders. However, during initial setup or training, Operators may be exposed to accidental contact with parts of the robot that are beneath the body of the robot (a) or up to 1000 mm from the ground (b).

In case of a tip-over, the legs are powerless. However, residual movement of loose legs may be generated by the fall.



### 8.4.6 Potential contact when far from the robot

In the unlikely event of loss of stability due to sudden and unpredictable conditions of the walking surface, Spot will normally disable power to the legs. In most cases of walking at low/moderate speed on almost flat surfaces or minor obstacles, Spot will lower its body as depicted in (a).

However, the conditions of the ground may determine a further displacement of the de-energized robot in the direction of gravity if a tip-over occurs on a flat incline or stairs as depicted in (c).

Spot will attempt to lower its body under gravity before de-energization as depicted in (a). Spot’s legs are not blocked when the robot is commanded to stop or de-energized.

	<p>A random blocked configuration of the legs would likely result in an unbalanced condition for the whole robot.</p> <p>Spot is never stopped with blocked legs. A random blocked configuration of the legs would likely result in an unbalanced condition for the whole robot, causing additional hazards.</p>
---	--

Voluntarily stopping Spot in case of emergency or as a result of activation of its protective stop from safe inputs on payload ports will remove actuation energy to its motors. A forced stopping event in conditions of active balancing as depicted in (c) may determine conditions for contacts along the direction of powerless motion.

Refer to [5.6 Stopping the robot](#) for more details.

Loss of power is a very rare event. When occurring during active balancing as depicted in (c), it may determine conditions for contacts along the direction of powerless motion.

	<p>Survey the assigned working area of Spot for locating parts of the layout, if present, where a sliding situation may happen.</p> <p>DO NOT enter or stay inside designated restricted areas.</p> <p>DO NOT stay within 2 m of Spot.</p>
---	--

### 8.4.7 Residual risks with contact events

Residual risks are evaluated with respect to the foreseeable conditions for contact events.

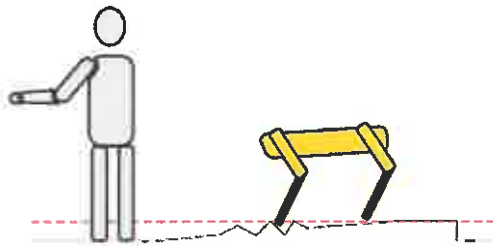

**Maximum elevation:**

- 300 mm
- Potential impact: feet and lower legs

**Residual risk:** Very low.

**Instructions:** Stay at least 2m away.



**Maximum elevation:**

- 1100 mm
- Potential impact: feet and legs

**Residual risk:** Low. Impacts from the back may result in loss of balance in a bystander.

Lateral impacts to the knees of bystanders may be harmful.

**Instructions:** Stay at least 2m away.

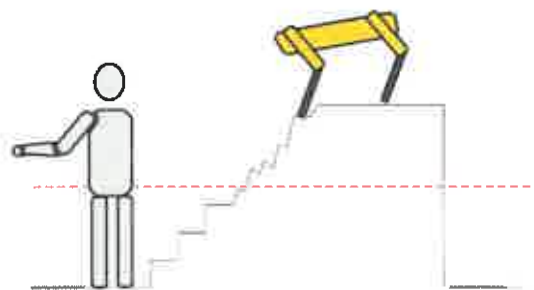

**Maximum elevation:**

- >1100 mm
- Potential impact: full body

**Residual risk:** Significant if stairs or inclined surfaces are very long.

Significant if cliff edges are not properly prepared.

Exposure of the human upper body (torso) is unlikely.

**Instructions:** Eliminate open cliff edges.

Stay at least 2m away from the bottom of stairs or inclined surfaces in Spot designated areas.



## 8.5 Pinch points during motion

This section provides information about pinch points in situations other than handling and transportation.

Spot is not intended to be used in close proximity to Operators, observers, or bystanders. Do not approach Spot while it is moving. Some residual pinch points are present around the joints and legs and cannot be entirely eliminated without compromising the mobility of the legs, or the ability to walk and maintain balance.

The upper legs can get very close to the body of Spot in any rolling or other movement that changes the attitude of the robot.

## 8.6 Risks associated with changes in mission profiles

Unexpected motion or loss of balance are known but infrequent events. The following conditions may affect the occurrence of such events:

- Movable, tilting or floating platforms or portions of walking surfaces in the area of operation that occur after the preparation of the environment.
- Areas of the environment such as the walking surface are rendered weak, fragile or unstable by changes in the operational layout. Examples: construction or excavation.
- Lubricants or other hazardous/slippery materials that occur in the operational environment and are not detected and resolved by site management.
- Undetected damages such as broken pipes, cords or unstable materials in the operational environment.

Any changes in the access restrictions to the areas assigned to Spot operations should be communicated to robot Operators.

## 9 Compliance statement

### 9.1 EU Declaration of Conformity

Products in the scope of the Declaration of Conformity:

- Spot robot Model 02-040236-001(Explorer) and Model 04-00143531-001 (Enterprise): legged robot (multiple axes controlled machine that uses articulated limbs for locomotion), which is remotely controlled by means of a wireless controller, intended for professional use in industrial, restricted or controlled environments.
- Spot Controller (Model: 03-000845-002): wireless controller for Spot robot

	A complete description of the intended use as part of the product description, including the limitations about environment, preparation and restriction of environment, requirements for training, is given in section 2 <a href="#">Product safety overview</a> .
---	--

It is declared that Spot, for what is supplied, fulfills all the relevant provisions of the following directives: Machinery Directive 2006/42/EC and amend. (MD), EMC Directive 2014/30/EU and amend. (EMCD), Radio Equipment Directive 2014/53/EU and amend. (RED)

List of Harmonized Standards used, as referred to individual Directives:

- MD, per Art. 7(2): EN ISO 12100:2010, EN 60204-1:2018,
- EMCD, per Art. 13: EN 61000-6-4:2007/A1:2011, EN 61000-6-2:2005/AC:2005
- RED, per Art. 16: ETSI EN 301 489-1 V2.2.1 (2019), ETSI EN 301 489-17 V3.2.2 (2019), EN 55032:2012

Other Technical Standards that are used for design requirements are EN IEC 62133-2:2017, EN IEC 62368-1:2014, EN IEC 60825-1:2014/A11:2020.

The Spot robot is to be used only with the following accessories:

- Spot Battery
- Spot Power Supply (optional)
- Spot Dock (Enterprise only, optional)



## 9.2 Validity of declaration

Spot is a complete machine according to the Machinery Directive, subject to the limitations covered in the intended use and in the environmental conditions. See section 2 [Product safety overview](#).

The following conditions would constitute a “substantial modification to the machinery:”

- The assembly and integration of active payloads with the ability of determining functions of Spot and/or sharing its control actions
- Integration of additional systems or equipment with the ability of determining functions of Spot and/or resulting in coordinated control
- Any active or passive payloads (see section [4.3 Spot robot payloads](#)) intended to have physical interaction with the environment, specifically, Spot Arm
- Safety-related radiating payloads (see section [4.3.2 Safety-related payloads](#))
- Any use different from the intended use

Substantial modifications change the original function of Spot and therefore, the Declaration of Conformity issued by Boston Dynamics is no longer valid. The newly integrated robot system and/or application, consisting of Spot and any additional devices or changes in function, will be subject to the User:

- Performing a risk assessment for the new intended use
- Validating the correct integration and conditions for safeguards and other protective measures
- Verifying that the system conforms with the provisions of the Machinery Directive and other applicable Directives
- Affixing a new CE mark to report the identification of the newly integrated robot system
- Signing a new Declaration of Conformity

## 9.3 Marking

The CE mark appears on the product as proof of conformity with the Machinery Directive and the Radio Equipment Directive.

The year of production can be found in the serial number. Explanation Serial number is sequential but year can be found as follows: BD-<Y><#####> Y = last digit of the year.

